



H O M E

l i g h t i n g



linealight

linealight



Home.

Movement, daily.

Stability, family.

Lunch with friends.

Romantic dinner.

Joy, delusion, surprise.

Emotions, mood.

Personal sensations. Individual.

Harmony with myself.

Relax, reading.

Ssssh, silence!

Shadow, half-light.

Light. Means life

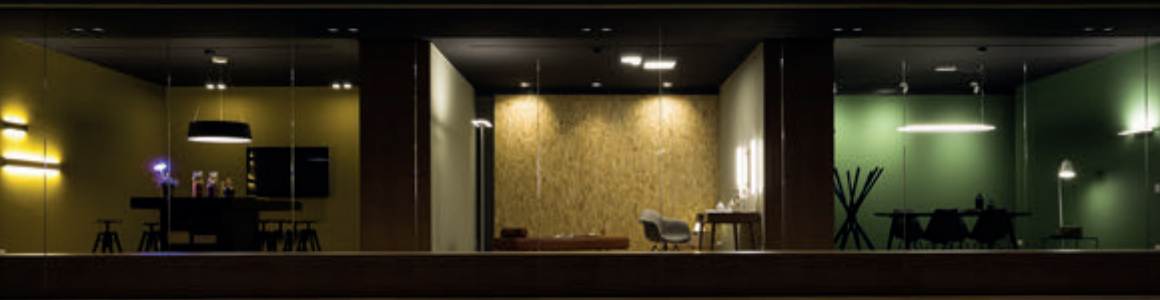



1985. 2017. The Linea Light Group decorative proposal is an ongoing evolution, anticipating market changes. More than thirty years summarized in few, simple words. Dedication, will, passion. A pinch of unconsciousness. Enterprise, in believing, among the first in the lighting world, in the extraordinary LED's technology potentiality, offering performative products to a wider range audience, demanding and sensitive to energy saving themes. Aesthetic, enclosed in the Made in Italy. Essence, giving life to concrete and functional shapes, modern finishes, products that Linea Light Group converts, today, in the **new collection Home Lighting 2017.**



Home Lighting means solutions suitable for all living spaces, to emphasize modern and refined living areas; driving to sleeping and saying good-morning, defining sleeping area with simplicity and beauty. The new collection offers spotlight solutions, a punctual lighting for architectural details or furnishing, spotlighting corridors, stairways, hallways. Modern solutions for bathrooms, fresh and iconic for the outdoor.

The **research** in Linea Light Group is always at the forefront in products' design. Home Lighting collection offers LED sources CRI 90, allowing the best colors reproduction fidelity, closer to the human eye transposes them in natural sunlight. A light able to define every single detail, to underline every color's shade, enhancing domestic spaces and giving consistency to architectural details and furniture. Choosing a warm white light temperature, aiming at relaxing and correct lighting in every space. The combination between color rendering CRI 90 and color temperature 3000 K enhances psychophysical wellbeing without inhibiting melatonin's production, a fundamental element for the correct sleep/wake up phase. These details make the difference, when we talk about living. Details on which Linea Light Group bases its success from 1985.



Historicity, technology and versatility, today, are expressed in Home Lighting 2017.

5

YEARS WARRANTY

Linea Light Group offers a 5-year warranty on its products against manufacturing defects, subject to filling in the activation form available at www.linealight.com. In the absence of activation, the statutory warranty remains valid.

All power supply, wiring and accessories used for product installation shall be original Linea Light Group parts or approved by the company. The warranty will become void if non original or non approved parts are used.

For more information, please visit our website www.linealight.com









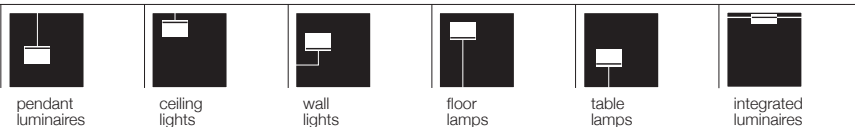

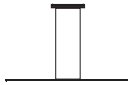
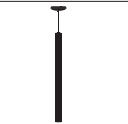
**home
lighting
1.0**

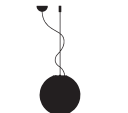
Collection



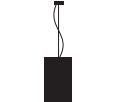















PRODUCT INDEX

indoor









Product Name	Page (P.)	Table (T.)	pendant luminaires	ceiling lights	wall lights	floor lamps	table lamps	integrated luminaires
 STRAIGHT_P new	P. 018	T. 023	●					
 TU-O_TU-V new	P. 024	P. 029	●					
 MOVE	P. 030	T. 033	●	●				
 SQUASH	P. 034	T. 038	●	●	●	●	●	
 STARDUST	P. 042	T. 045	●	●				
 HORIZON new	P. 046	T. 049	●	●				
 BOX_FULL LIGHT new	P. 050	T. 052		●	●			
 BOX	P. 054	T. 060		●	●		●	
 ROSE	P. 068	T. 070	●	●				
 GLUÈD	P. 072	T. 078	●	●	●			
 DUBLIGHT upgraded	P. 082	T. 088	●	●	●	●	●	
 MILLE	P. 092	T. 097	●	●	●			
 CURVÈ upgraded	P. 104	T. 108			●			











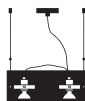

PRODUCT INDEX

indoor								
			pendant luminaires	ceiling lights	wall lights	floor lamps	table lamps	integrated luminaires
	HELI	P. 110 T. 113				●		
	CONUS	P. 114 T. 121	●	●		●	●	●
	SNAKE	P. 124 T. 129		●	●	●		
	BART	P. 133 T. 135		●	●			
	ONE TO ONE	P. 136 T. 138		●				●
	BEEBO	P. 140 T. 143		●	●			
	INCASSO upgraded	P. 144 T. 146						●
	GYPSUM_CELL new	P. 150 T. 153						●
	GYPSUM_R GYPSUM_O GYPSUM_EYE GYPSUM_ILL	P. 154 T. 160						●
	GYPSUM_Q GYPSUM_D GYPSUM_S	P. 168 T. 174		●				●
	GYPSUM_W GYPSUM_WR GYPSUM_WF	P. 182 T. 186			●			●
	OUTLOOK upgraded	P. 192 T. 195	●	●				●
	PELOTA	P. 196 T. 201	●	●	●			



















PRODUCT INDEX

indoor

					
pendant luminaires	ceiling lights	wall lights	floor lamps	table lamps	integrated luminaires

	SPOTTY	P. 203 T. 206							
	ORBIS	P. 210 T. 214							
	CRUMB new	P. 216 T. 219							
	CAMPANA	P. 220 T. 223							
	THANK YOU new	P. 226 T. 236							
	SISTERS new	P. 242 T. 245							
	VULCANO	P. 246 T. 249							
	ZIG ZAG	P. 250 T. 252							
	FACE	P. 254 T. 256							
	CREW new	P. 258 T. 261							
	TARA new	P. 264 T. 267							
	SPARK new	P. 270 T. 273							
	JOSHUA new	P. 275 T. 277							

PRODUCT INDEX

indoor								
			pendant luminaires	ceiling lights	wall lights	floor lamps	table lamps	integrated luminaires
	ZEBRA new	P. 278 T. 280		●	●			
	POE new	P. 282 T. 287	●			●		
	BABY MARGE	P. 288 T. 291					●	
	METAL new	P. 292 T. 295		●	●			
	MOLEDRO upgraded	P. 298 T. 301	●	●	●			
	MADERA	P. 304 T. 306		●	●			
	SOLIDO	P. 308 T. 311		●	●			
	SIPARIO	P. 312 T. 314		●	●			
	NOVE99	P. 312 T. 314		●	●			
	HULA HOOP	P. 316 T. 317		●	●			
	TRIAD	P. 320 T. 322	●	●	●			
	ECOMOLLA	P. 324 T. 326		●	●			
	BILANCIA	P. 324 T. 326		●	●		●	

PRODUCT INDEX

indoor



pendant
luminaires



ceiling
lights



wall
lights















floor
lamps





















table
lamps









integrated
luminaires

	LINER	P. 328 T. 332		●	●		
	LANCIA	P. 328 T. 333		●	●		
	DELTA	P. 328 T. 334		●	●		
	LUMINOSA	P. 336 T. 338		●	●		
	ONDA	P. 340 T. 343		●	●		
	MARINA	P. 340 T. 344		●	●		
	ICEBERG	P. 340 T. 345		●	●		
	WALLY	P. 346 T. 348				●	
	MET WALLY	P. 346 T. 349				●	
	MATRIOSKA	P. 350 T. 352	●	●	●		
	MAMI	P. 354 T. 357	●	●	●		●
	ARTIC	P. 360 T. 365	●	●	●		
	SYBERIA	P. 360 T. 365		●	●		

















PRODUCT INDEX

indoor								
			pendant luminaires	ceiling lights	wall lights	floor lamps	table lamps	integrated luminaires
	OH!_IN upgraded	P. 370 T. 378	●	●	●	●		
	OHPS_IN	P. 382 T. 386	●	●		●		
	OH! SMASH_IN	P. 388 T. 390	●	●		●		
	STRAIGHT_W new	P. 392 T. 395				●		
	HALFPIPE new	P. 396 T. 401				●		
	KIOO	P. 402 T. 405				●		
	SKINNY	P. 406 T. 410				●		
	CIRCULAR new	P. 412 T. 415				●		
	ALOHA	P. 416 T. 419				●		
	PRIME	P. 416 T. 419				●		
	SOLID	P. 420 T. 424				●		
	GOCCIA	P. 426 T. 430				●	●	
	BOLL	P. 426 T. 430		●	●			

PRODUCT INDEX

indoor								
			pendant luminaires	ceiling lights	wall lights	floor lamps	table lamps	integrated luminaires
	FOTIS	P. 432 T. 434				●		
	ELIPSE	P. 439 T. 441				●		
	DICE	P. 439 T. 441				●		
	CUBIC	P. 439 T. 441				●		
	MONO SYSTEM upgraded	P. 442 T. 446						●
	150 SYSTEM upgraded	P. 452 T. 456						●
	300 SYSTEM upgraded	P. 464 T. 468						●

PRODUCT INDEX

outdoor								
			pendant luminaires	ceiling lights	wall lights	floor lamps	table lamps	integrated luminaires
	MYWHITE	P. 476 T. 481		●	●			
	PLAF	P. 486 T. 488		●	●			
	OH!_OUT upgraded	P. 490 T. 496	●	●	●	●		
	OHPS_OUT	P. 502 T. 504		●		●		
	OH! SMASH_OUT	P. 506 T. 508	●	●		●		
	OH! SOLAR new	P. 512 T. 515					●	
	OH! UW	P. 516 T. 518					●	
	MARGE	P. 520 T. 523					●	
	PEGGY	P. 524 T. 526					●	
	FLOWER	P. 528 T. 531					●	
	ELECTRONICS	P. 534						
	INDEX CODE	P. 542						



STRAIGHT_P /



^ STRAIGHT_P UPWARD EMISSION
< STRAIGHT_P DOWNWARD EMISSION



STRAIGHT_P DIFFUSED/DIRECT EMISSION



STRAIGHT_P DIFFUSED/DIRECT EMISSION



STRAIGHT_P PENDANT LUMINAIRES

Straight_P | Linear essence. One or three extra thin light lines, freely combinable suspension. With its simplicity, everything is stylishly minimal.

Materials: white or black wrinkled coating setting, polycarbonate diffuser.

Straight_P1 | Pendant Luminaires | 220-240 V | topLED 11 W 350 mA

new



type

White	CRI 90	8200
Black	CRI 90	8204

colour

2700 K 1519 lm

optics

diffused

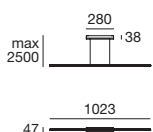

Straight_P1 | Pendant Luminaires | 220-240 V | topLED 18 W 350 mA

new



type

White	CRI 90	8201
Black	CRI 90	8205

colour

2700 K 2279 lm

optics

diffused

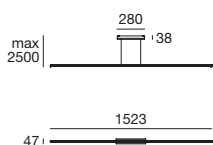

Straight_P3 | Pendant Luminaires | 220-240 V | topLED 34 W 1050 mA

new



type

White	CRI 90	8202
Black	CRI 90	8206

colour

2700 K 4557 lm

optics

diffused

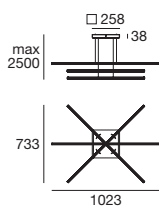

Straight_P3 | Pendant Luminaires | 220-240 V | topLED 49 W 1050 mA

new



type

White	CRI 90	8203
Black	CRI 90	8207

colour

2700 K 6836 lm

optics

diffused

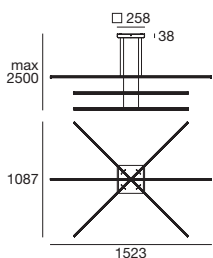



new

TU-V_TU-O /



^ TU-O PENDANT LUMINAIRES
< TU-V PENDANT LUMINAIRES





Tu-O_Tu-V | Tubular lighting, vertical or horizontal, in different lengths. Combinable in vertical cascades or in elaborated lighting ceiling forests, essential lighting sculpture.

Materials: natural polythene diffuser, white coated aluminum closing cap.

Tu-O | Pendant Luminaires | 220-240 V | topLED 36 W 700 mA

new     

type	colour	optics
White CRI 90 8198	3000 K 4662 lm	diffused

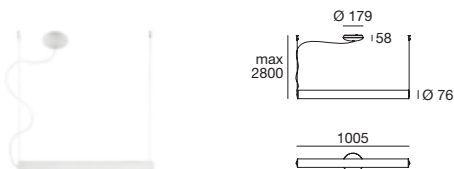

Tu-O | Pendant Luminaires | 220-240 V | topLED 56 W 1050 mA

new     

type	colour	optics
White CRI 90 8199	3000 K 6993 lm	diffused

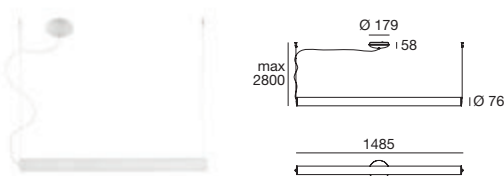



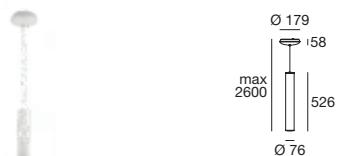

Tu-V | Pendant Luminaires | 220-240 V | topLED 20 W 350 mA

new     

type	colour	optics
White CRI 90 8195	3000 K 2331 lm	diffused





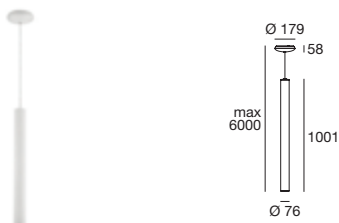

Tu-V | Pendant Luminaires | 220-240 V | topLED 36 W 700 mA

new     

type	colour	optics
White CRI 90 8196	3000 K 4662 lm	diffused



Tu-V | Pendant Luminaires | 220-240 V | topLED 54 W 350 mA

new     

type	colour	optics
White CRI 90 8197	3000 K 6993 lm	diffused

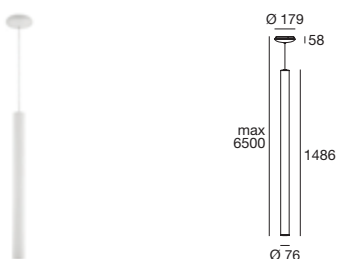



MOVE /



^ MOVE PENDANT LUMINAIRES
< MOVE CEILING LIGHTS



MOVE PENDANT LUMINAIRES

Move | A circle suspended in the air tips at will, following your desire to play with the light.

Materials: white or black wrinkle-effect coated metal casing; polyethylene diffuser; white or black fabric band.

Move_P | Pendant Luminaires | 220-240 V | topLED 29 W 700 mA

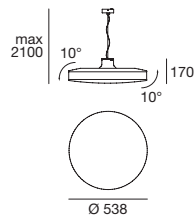

type

White	CRI 90	7829
Black	CRI 90	7830

colour

3000 K 3929 lm

optics

diffused

Move_P | Pendant Luminaires | 220-240 V | 1x2GX13

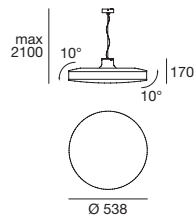

type

White	7823
Black	7824

source

Fluorescent 1x55 W (included)

optics

diffused

Move_S | Ceiling Lights | 220-240 V | topLED 29 W 700 mA

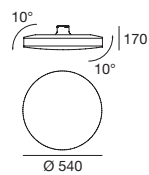

type

White	CRI 90	7826
Black	CRI 90	7827

colour

3000 K 3929 lm

optics

diffused

Move_S | Ceiling Lights | 220-240 V | 1x2GX13

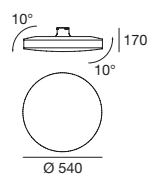

type

White	7820
Black	7821

source

Fluorescent 1x55 W (included)

optics

diffused



SQUASH /



^ SQUASH PENDANT LUMINAIRES
< SQUASH PENDANT LUMINAIRES
< SQUASH FLOOR LAMPS

SQUASH PENDANT LUMINAIRES





SQUASH TABLE LAMPS

Squash | Elliptical and essential, it enlivens the surrounding space creating a friendly, relaxing atmosphere thanks to its warm and inviting diffused lighting.

Materials: white linear polyethylene diffuser; white wrinkle-effect coated metal casing and mounting frame.

Squash_P | Pendant Luminaires | 220-240 V | topLED 9 W 50 mA

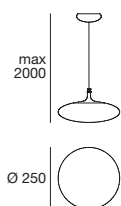
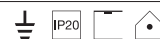

type

White CRI 90 **7948**

colour

3000 K 870 lm

optics

diffused

accessories



KIT0026

Phase-cut Dimmer



Squash_P | Pendant Luminaires | 220-240 V | topLED 19 W 50 mA

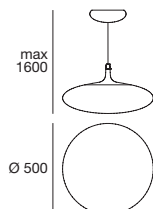

type

White CRI 90 **7627**

colour

3000 K 2364 lm

optics

diffused

Squash_S | Ceiling Lights | 220-240 V | topLED 9 W 50 mA

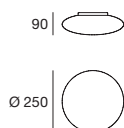
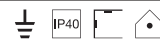

type

White CRI 90 **7951**

colour

3000 K 870 lm

optics

diffused

accessories



KIT0026

Phase-cut Dimmer

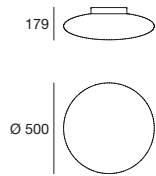

Squash_S | Ceiling Lights | 220-240 V | topLED 19 W 500 mA**type**White CRI 90 **7626****colour**

3000 K 2364 lm

optics

diffused

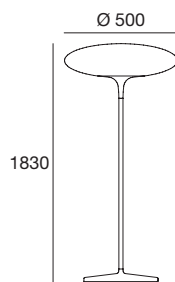
Squash_FL | Floor Lamps | 220-240 V | topLED 25 W 700 mA**type**White CRI 90 **7628****colour**

3000 K 3062 lm

optics

diffused

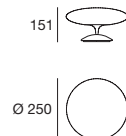
Squash_tab | Table Lamps | 220-240 V | topLED 9 W 500 mA**type**White CRI 90 **7946****colour**

3000 K 870 lm

optics

diffused

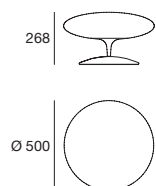
Squash_tab | Table Lamps | 220-240 V | topLED 19 W 500 mA**type**White CRI 90 **7947****colour**

3000 K 2364 lm

optics

diffused

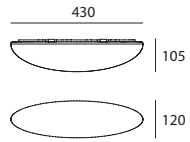

type

White CRI 90 **8027**

colour

3000 K 970 lm

optics

diffused

Complete the Squash family with the wall lamp My White_O.





STARDUST /

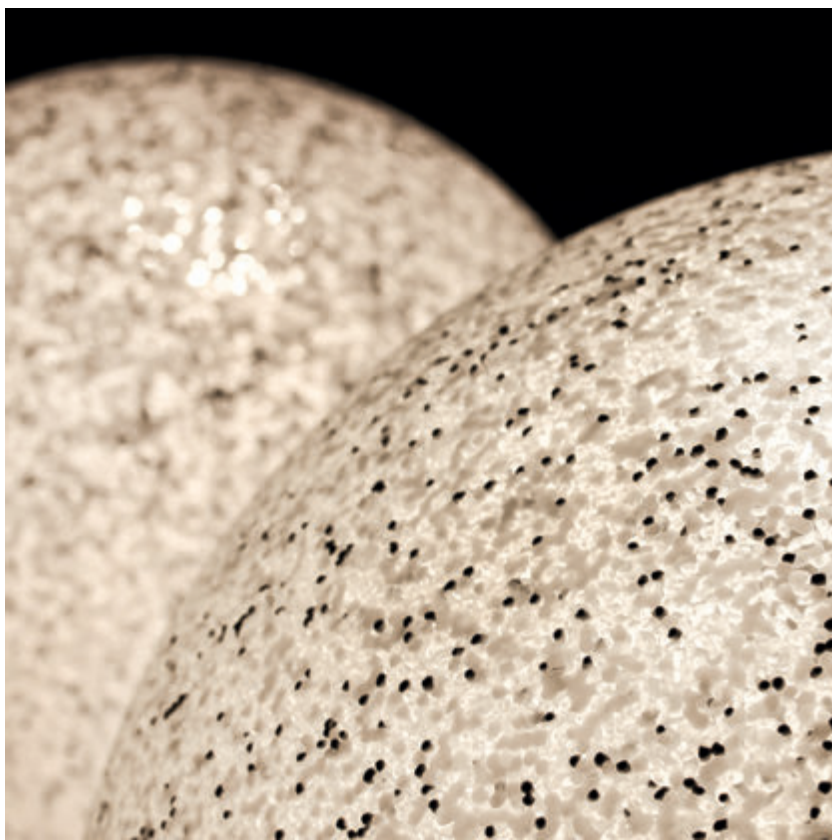

STARDUST PENDANT LUMINAIRES

STARDUST PENDANT LUMINAIRES



Stardust | Light diffused and maximized by the spherical shape, gleaming through narrow lines, playfully interacting with the environment: a luminaire with a granular texture and evocative lighting.

Materials: base in white wrinkle-effect coated metal or in white polyethylene; translucent/white polypropylene diffuser.

Stardust_P | Pendant Luminaires | 220-240 V | Module 15 W 350 mA

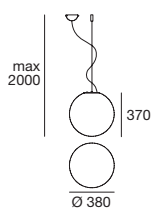
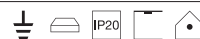

type

White CRI 90 **7891**

colour

3000 K 1455 lm

optics

diffused

Stardust_P | Pendant Luminaires | 220-240 V | Module 25 W 700 mA

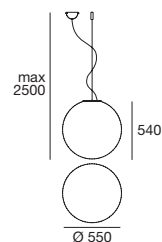
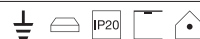

type

White CRI 90 **7892**

colour

3000 K 3063 lm

optics

diffused

Stardust_S | Ceiling Lights | 220-240 V | Module 15 W 350 mA

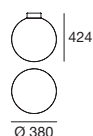
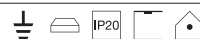

type

White CRI 90 **7893**

colour

3000 K 1455 lm

optics

diffused

Stardust_S | Ceiling Lights | 220-240 V | Module 25 W 700 mA

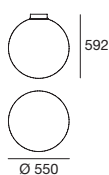
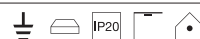

type

White CRI 90 **7894**

colour

3000 K 3063 lm

optics

diffused



new

HORIZON /



HORIZON PENDANT LUMINAIRES



HORIZON CEILING LIGHTS

Horizon | Reflecting and diffusing light flying disc, white diffuser spreads indirect lighting diffusing on worktop without leaking. A strong impact scenographic suspension or ceiling lamp.

Materials: white or black wrinkled coating setting, blast-sanded or serigraph diffuser.

Horizon_P | Pendant Luminaires | 220-240 V | topLED 34 W 700 mA



new

type

White CRI 90 **90286**

colour

3000 K 3214 lm

optics

diffused

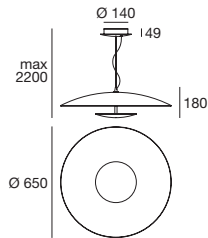

Horizon_S | Ceiling Lights | 220-240 V | topLED 34 W 700 mA



new

type

White CRI 90 **90285**

colour

3000 K 3214 lm

optics

diffused

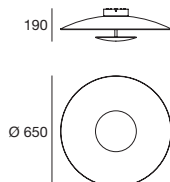



new

BOX_FULL LIGHT /



BOX FULL LIGHTS

Box_Full Light | Ceiling mounted and wall mounted lighting fixtures with minimal and versatile shapes leave space for light, the true protagonist with a discrete presence.

Materials: white linear polyethylene diffuser.

Box_R Full light | Ceiling Light | 220-240 V | topLED 27 W 700 mA

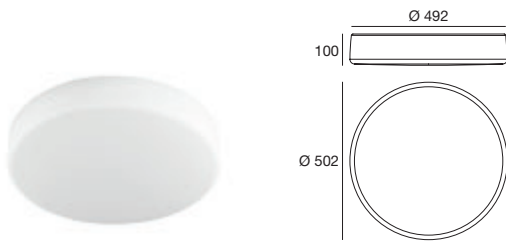

new



type	colour	optics
White CRI 90 8160	3000 K 3117 lm	diffused
type	colour	optics
White CRI 90 8160N	4000 K 3432 lm	diffused

Box_Q Full light | Ceiling Light | 220-240 V | topLED 27 W 700 mA

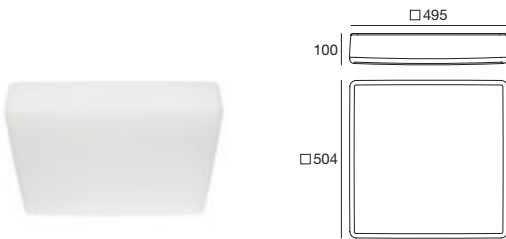

new



type	colour	optics
White CRI 90 8162	3000 K 3117 lm	diffused
type	colour	optics
White CRI 90 8162N	4000 K 3432 lm	diffused



BOX /



BOX CEILING LIGHTS

BOX CEILING LIGHTS







BOX CEILING LIGHTS

BOX WALL LIGHTS



Box | Ceiling mounted and wall mounted lighting fixtures with minimal and versatile shapes leave space for light, the true protagonist with a discrete presence.

Materials: mounting frame in white wrinkle-effect coated metal or with grey, chrome, nickel or concrete finishes. Satin-finished polymethylmethacrylate diffuser.

Box_SR | Ceiling Lights | 220-240 V | topLED 7 W 500 mA

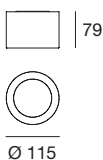

type	colour	optics
White CRI 90 8236	3000 K 752 lm	diffused
Concrete CRI 90 8237		

type	colour	optics
White CRI 90 8236N	4000 K 811 lm	diffused
Concrete CRI 90 8237N		



on request

Box_SR | Ceiling Lights | 220-240 V | topLED 17 W 500 mA

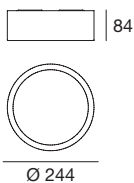

type	colour	optics
White CRI 90 8238	3000 K 1880 lm	diffused
Concrete CRI 90 8239		

type	colour	optics
White CRI 90 8238N	4000 K 2027 lm	diffused
Concrete CRI 90 8239N		



on request

Box_SR | Ceiling Lights | 220-240 V | topLED 25 W 700 mA

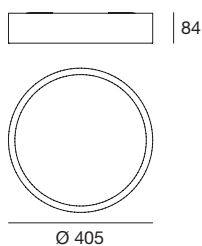

type	colour	optics
White CRI 90 8240	3000 K 2878 lm	diffused
Concrete CRI 90 8241		

type	colour	optics
White CRI 90 8240N	4000 K 3108 lm	diffused
Concrete CRI 90 8241N		

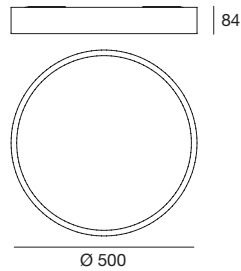

on request

Box_SR | Ceiling Lights | 220-240 V | topLED 48 W 1000 mA

on request

typeWhite CRI 90 **8242**Concrete CRI 90 **8243****colour**

3000 K 5232 lm

optics

diffused

typeWhite CRI 90 **8242N**Concrete CRI 90 **8243N****colour**

4000 K 5650 lm

optics

diffused

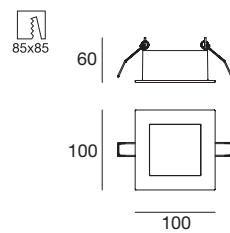
Box_C | Downlights | topLED 5 W 350 mA

on request

typeWhite CRI 90 **8225**Concrete CRI 90 **8226****colour**

3000 K 565 lm

optics

diffused

typeWhite CRI 90 **8225N**Concrete CRI 90 **8226N****colour**

4000 K 588 lm

optics

diffused

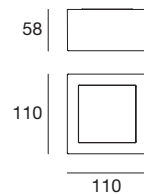
electronics**KIT72**ON/OFF Driver
1-3 art.**Box_SQ** | Ceiling Lights | 220-240 V | topLED 7 W 500 mA

on request

typeWhite CRI 90 **8227**Concrete CRI 90 **8228****colour**

3000 K 752 lm

optics

diffused

typeWhite CRI 90 **8227N**Concrete CRI 90 **8228N****colour**

4000 K 811 lm

optics

diffused

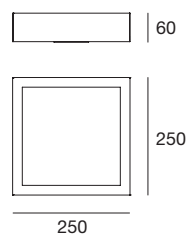
Box_SQ | Ceiling Lights | 220-240 V | topLED 17 W 700 mA

on request

typeWhite CRI 90 **8229**Concrete CRI 90 **8230****colour**

3000 K 1880 lm

optics

diffused

typeWhite CRI 90 **8229N**Concrete CRI 90 **8230N****colour**

4000 K 2027 lm

optics

diffused

Box_SQ | Ceiling Lights | 220-240 V | topLED 25 W 700 mA

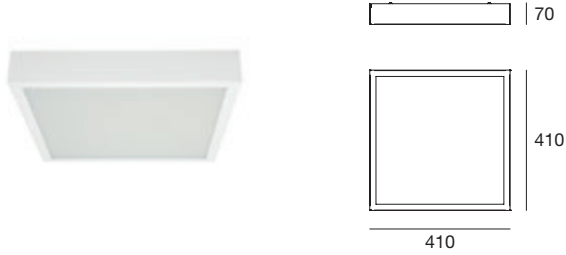

on request

type

White CRI 90 **8231**

Concrete CRI 90 **8232**

colour

3000 K 3060 lm

optics

diffused

type

White CRI 90 **8231N**

Concrete CRI 90 **8232N**

colour

4000 K 3283 lm

optics

diffused

Box_SQ | Ceiling Lights | 220-240 V | topLED 43 W 500 mA

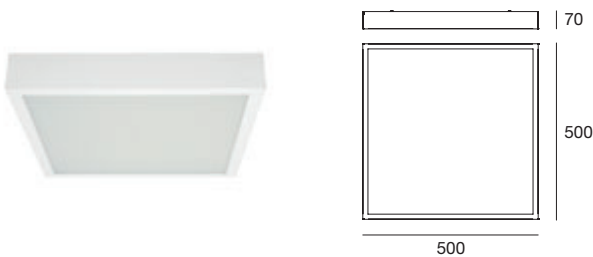

on request

type

White CRI 90 **8233**

Concrete CRI 90 **8234**

colour

3000 K 4888 lm

optics

diffused

type

White CRI 90 **8233N**

Concrete CRI 90 **8234N**

colour

4000 K 5270 lm

optics

diffused

Box_SB | Ceiling Lights | 220-240 V | topLED 20 W 350 mA

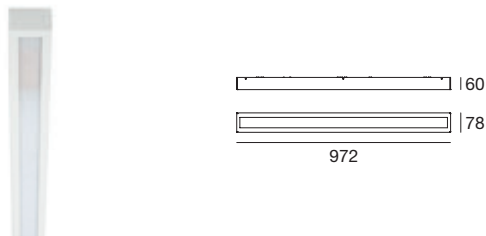

on request

type

White CRI 90 **8259**

Concrete CRI 90 **8253**

colour

3000 K 2543 lm

optics

diffused

type

White CRI 90 **8259N**

Concrete CRI 90 **8253N**

colour

4000 K 2642 lm

optics

diffused

Box_SB | Ceiling Lights | 220-240 V | topLED 26 W 700 mA

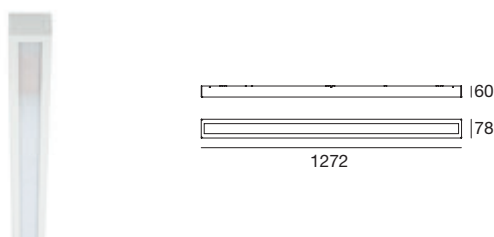

on request

type

White CRI 90 **8260**

Concrete CRI 90 **8254**

colour

3000 K 3390 lm

optics

diffused

type

White CRI 90 **8260N**

Concrete CRI 90 **8254N**

colour

4000 K 3523 lm

optics

diffused

Box_W | Wall Lights | 220-240 V | stripLED 10 W 500 mA

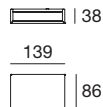

type

White CRI 90 **8255**Concrete CRI 90 **8261**

colour

3000 K 1122 lm

optics

diffused

type

White CRI 90 **8255N**Concrete CRI 90 **8261N**

colour

4000 K 1156 lm

optics

diffused



on request

Box_W | Wall Lights | 220-240 V | stripLED 19 W 500 mA

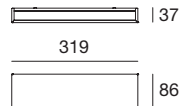

type

White CRI 90 **8256**Concrete CRI 90 **8262**

colour

3000 K 2256 lm

optics

diffused

type

White CRI 90 **8256N**Concrete CRI 90 **8262N**

colour

4000 K 2433 lm

optics

diffused



on request

Box_W | Wall Lights | 220-240 V | stripLED 28 W 700 mA

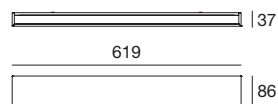

type

White CRI 90 **8257**Concrete CRI 90 **8263**

colour

3000 K 3390 lm

optics

diffused

type

White CRI 90 **8257N**Concrete CRI 90 **8263N**

colour

4000 K 3523 lm

optics

diffused



on request

Box_W | Wall Lights | 220-240 V | stripLED 41 W 700 mA

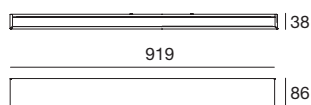

type

White CRI 90 **8258**Concrete CRI 90 **8264**

colour

3000 K 5085 lm

optics

diffused

type

White CRI 90 **8258N**Concrete CRI 90 **8264N**

colour

4000 K 5284 lm

optics

diffused



on request

Box_SQ | Ceiling Lights | 220-240 V | 1xG9

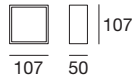

type

White	4700
Grey	4703
Chrome	4701
Nickel	4702

source

Halogen 1x48 W
(included)

optics

diffused

Box_SQ | Ceiling Lights | 220-240 V | 1x2G10

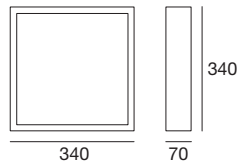

type

White	71649
Grey	71650
Chrome	71652
Nickel	71651

source

Fluorescent 1x36 W
(included)

optics

diffused

Box_SQ | Ceiling Lights | 220-240 V | 1x2G10

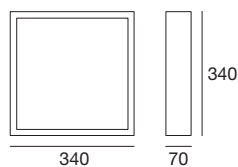

type

White	71649/EM
Grey	71650/EM
Chrome	71652/EM
Nickel	71651/EM

source

Fluorescent 1x36 W
(included)

optics

diffused



Box_SQ | Ceiling Lights | 220-240 V | 1xR7s

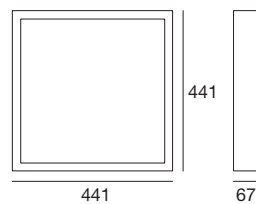

type

White	71653
Grey	71654
Nickel	71655
Chrome	71656

source

Halogen 1x80 W
(included)

optics

diffused

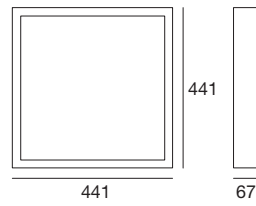
Box_SQ | Ceiling Lights | 220-240 V | 2x2G11**type**

White	71657
Grey	71658
Chrome	71660
Nickel	71659

source

Fluorescent 2x36 W
(included)

optics

diffused

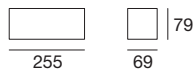
Box_W | Wall Lights | 220-240 V | 1x2G11**type**

White	6723
Grey	6722
Chrome	6720
Nickel	6721

source

Fluorescent 1x18 W
(included)

optics

diffused

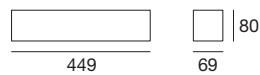
Box_W | Wall Lights | 220-240 V | 1x2G11**type**

White	6727
Grey	6726
Chrome	6724
Nickel	6725

source

Fluorescent 1x36 W
(included)

optics

diffused

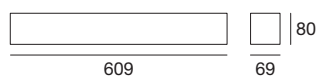
Box_W | Wall Lights | 220-240 V | 1x2G11**type**

White	6731
Grey	6730
Chrome	6728
Nickel	6729

source

Fluorescent 1x55 W
(included)

optics

diffused

type

White	6735
Grey	6734
Chrome	6732
Nickel	6733

source

Fluorescent 1x80 W
(included)

optics

diffused



BOX CONCRETE FINISH





ROSE /



^ ROSE PENDANT LUMINAIRES
< ROSE CEILING LIGHTS

Rose | Like a flower that opens, offering its colours, a ceiling and suspension light that offers its light as a spontaneous manifestation of beauty and grace.

Materials: white linear polyethylene diffuser; matt white coated metal casing.

Rose_P | Pendant Luminaires | 220-240 V | 2xE27

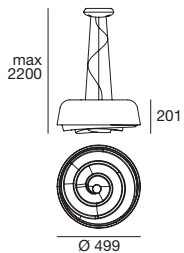
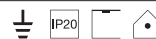

type

White 7655

source

2x46W Max

optics

diffused

Rose_P | Pendant Luminaires | 220-240 V | 3xE27

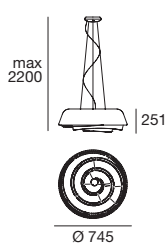
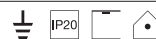

type

White 7657

source

3x46W Max

optics

diffused

Rose_S | Ceiling Lights | 220-240 V | 2xE27

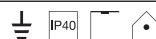

type

White 7656

source

2x46W Max

optics

diffused

Rose_S | Ceiling Lights | 220-240 V | 3xE27

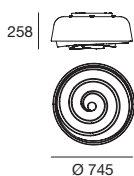

type

White 7658

source

3x46W Max

optics

diffused



new

GLUÈD /

Home Lighting 1.0_indoor

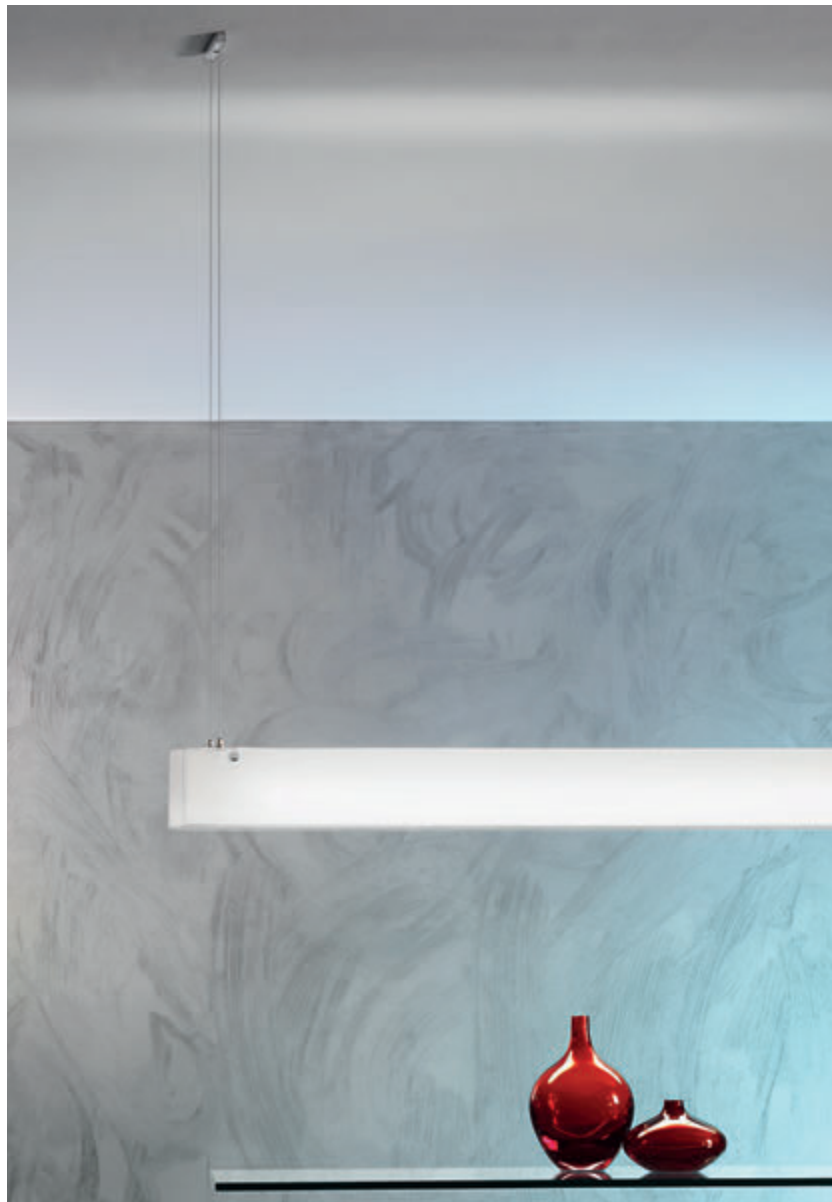

^ GLUED PENDANT LUMINAIRES
< GLUED CEILING LIGHTS

GLUED CEILING LIGHTS







GLUED CEILING LIGHTS



GLUED WALL LIGHTS

Gluèd | A wall, ceiling and suspension light with square and regular shapes offers a well-defined light, softer for observers, to fit discreetly into any environment, in any style.

Materials: matt white coated metal mounting frame; white silk-screened glass diffuser.

Gluèd_PQ1 | Pendant Luminaires | 220-240 V | 1xE27

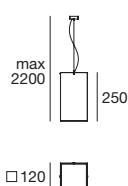
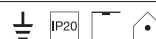

type

White **4897**

source

1x57 W Max

optics

diffused

Gluèd_PQ2 | Pendant Luminaires | 220-240 V | 2xE27

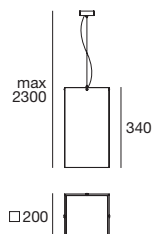
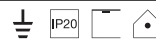

type

White **6668**

source

1x77 W Max

optics

diffused

Gluèd_PQ2 | Pendant Luminaires | 220-240 V | 1xE27

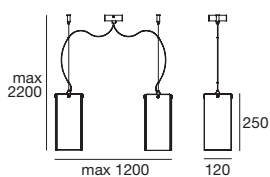
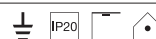

type

White **4899**

source

2x57 W Max

optics

diffused

Gluèd_PB | Pendant Luminaires | 220-240 V | topLED 29 W 1400 mA

new

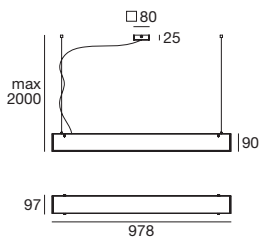
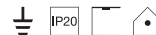

type

White CRI 80 **90308**

colour

3000 K 3067 lm

optics

diffused

Gluèd_PB | Pendant Luminaires | 220-240 V | topLED 41 W 1000 mA

new

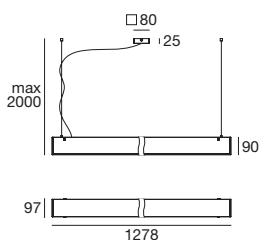
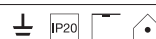

type

White CRI 80 **90309**

colour

3000 K 4508 lm

optics

diffused

Gluèd_SB | Ceiling Lights | 220-240 V | topLED 15 W 350 mA

new

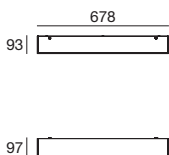

type

White CRI 80 **90302**

colour

3000 K 1570 lm

optics

diffused

Gluèd_SB | Ceiling Lights | 220-240 V | topLED 22 W 1000 mA

new

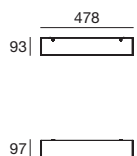
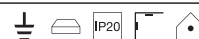

type

White CRI 80 **90303**

colour

3000 K 2254 lm

optics

diffused

Gluèd_SB | Ceiling Lights | 220-240 V | topLED 29 W 1400 mA

new



type

White CRI 80 **90304**

colour

3000 K 3067 lm

optics

diffused

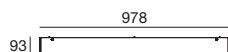

Gluèd_SB | Ceiling Lights | 220-240 V | topLED 41 W 1000 mA

new

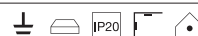

type

White CRI 80 **90305**

colour

3000 K 4508 lm

optics

diffused

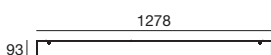

Gluèd_SQ | Ceiling Lights | 220-240 V | topLED 23 W 700 mA

new

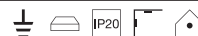

type

White CRI 80 **90306**

colour

3000 K 3060 lm

optics

diffused

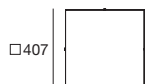
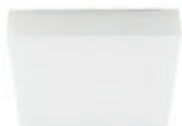

Gluèd_SQ | Ceiling Lights | 220-240 V | topLED 32 W 850 mA

new

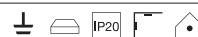

type

White CRI 80 **90307**

colour

3000 K 3782 lm

optics

diffused

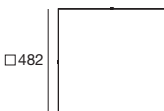

Gluèd_W | Wall Lights | 220-240 V | topLED 8 W 350 mA

new



type

White CRI 80 **90300**

colour

3000 K 785 lm

optics

diffused

Gluèd_W | Wall Lights | 220-240 V | topLED 15 W 350 mA

new

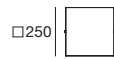

type

White CRI 80 **90301**

colour

3000 K 1630 lm

optics

diffused



Strategie



DUBLIGHT /



^ DUBLIGHT WALL LIGHTS
< DUBLIGHT TABLE LAMPS

DUBLIGHT PENDANT LUMINAIRES





DUBLIGHT CEILING LIGHTS



DUBLIGHT TABLE LAMPS



DUBLIGHT FLOOR LAMPS

Dublight | A luminaire with a contemporary design and minimalist lines, it adds an inimitable touch of style to the lit environment and stands out for its elegance and character.

Materials: white wrinkle-effect coated metal mounting frame; satin-finished polymethylmethacrylate diffuser.

Dublight_P | Pendant Luminaires | 220-240 V | topLED 23 W 700 mA

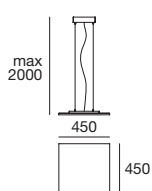

type

White CRI 90 **7492**

colour

3000 K 2985 lm

optics

diffused

Dublight_P | Pendant Luminaires | 220-240 V | topLED 42 W 1050 mA

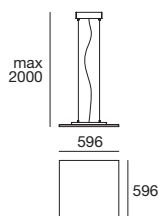

type

White CRI 90 **7493**

colour

3000 K 5010 lm

optics

diffused

Dublight_P | Pendant Luminaires | 220-240 V | topLED 35 W 700 mA

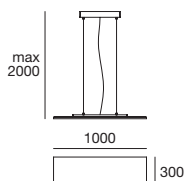

type

White CRI 90 **7494**

colour

3000 K 4478 lm

optics

diffused

Dublight_S | Ceiling Lights | 220-240 V | topLED 7 W 500 mA

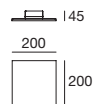

type

White CRI 90 **7488**

colour

3000 K 808 lm

optics

diffused

Dublight_S | Ceiling Lights | 220-240 V | topLED 23 W 700 mA

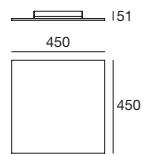

type

White CRI 90 **7489**

colour

3000 K 2835 lm

optics

diffused

Dublight_S | Ceiling Lights | 220-240 V | topLED 42 W 1050 mA

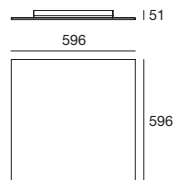

type

White CRI 90 **7490**

colour

3000 K 5010 lm

optics

diffused

Dublight_S | Ceiling Lights | 220-240 V | topLED 35 W 700 mA

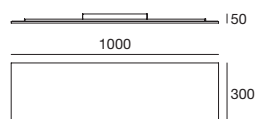

type

White CRI 90 **7491**

colour

3000 K 4478 lm

optics

diffused

Dublight_W | Wall Lights | 220-240 V | topLED 7 W 500 mA

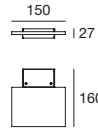

type

White CRI 90 **7485**

colour

3000 K 808 lm

optics

diffused

Dublight_W | Wall Lights | 220-240 V | topLED 13 W 500 mA

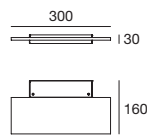

type

White CRI 90 **7486**

colour

3000 K 1680 lm

optics

diffused

Dublight_W | Wall Lights | 220-240 V | topLED 27 W 1000 mA

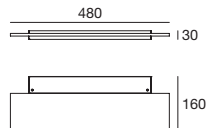

type

White CRI 90 **7487**

colour

3000 K 3360 lm

optics

diffused

Dublight_FL | Floor Lamps | 220-240 V | topLED 28 W 500 mA

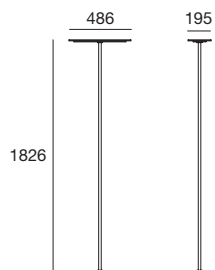

type

White CRI 90 **7496**

colour

3000 K 3360 lm

optics

diffused

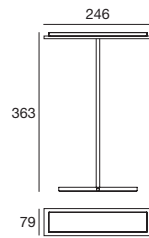
Dublight_tab | Table Lamps | 220-240 V | topLED 7 W 350 mA**type**

White	CRI 90	7495
-------	--------	-------------

colour

3000 K	835 lm
--------	--------

optics

diffused

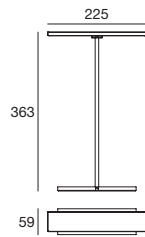
**Dublight_C tab** | Table Lamps | 220-240 V | topLED 7 W 350 mA**new****type**

White	CRI 90	7885
-------	--------	-------------

Black	CRI 90	7886
-------	--------	-------------

colour

3000 K	835 lm
--------	--------

optics

diffused





MILLE /



MILLE WALL LIGHTS



MILLE CEILING LIGHTS





MILLE PENDANT LUMINAIRES

Mille | Clean lines, a simple and attractive design, elegant glasswork: a ceiling or wall light for every room and every style.

Materials: glossy white coated metal mounting frame; diffuser made of white silk-screened, partly transparent (with brushed nickel finished decorative elements) or partly white sandblasted glass (with cherry wood or brushed nickel finished decorative elements).

Mille_SQ | Ceiling Lights | 220-240 V | topLED 29 W 1000 mA

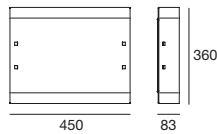

type

White	Nickel	7852
White	Cherry W.	

colour

3000 K 3229 lm

optics

diffused



sandblasted glass
nickel_cherry wood detail
cod. 7852

Mille_SB | Ceiling Lights | 220-240 V | topLED 34 W 1000 mA

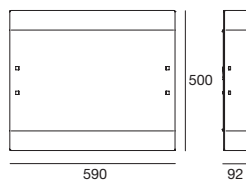

type

White	Nickel	7854
White	Cherry W.	

colour

3000 K 4132 lm

optics

diffused



sandblasted glass
nickel_cherry wood detail
cod. 7854

Mille_W1 | Wall Lights | 220-240 V | topLED 8 W 350 mA

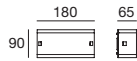

type

White	Nickel	7836
White	Cherry W	

colour

3000 K 835 lm

optics

diffused



sandblasted glass
nicke_cherry wood detail
cod. 7836

Mille_W1 | Wall Lights | 220-240 V | topLED 9 W 500 mA

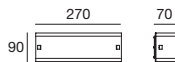

type

White	Nickel	7838
White	Cherry W	

colour

3000 K 1260 lm

optics

diffused



sandblasted glass
nicke_cherry wood detail
cod. 7838

Mille_W1 | Wall Lights | 220-240 V | topLED 14 W 700 mA

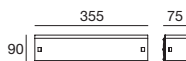

type

White	Nickel	7840
White	Cherry W	

colour

3000 K 1670 lm

optics

diffused



sandblasted glass
nicke_cherry wood detail
cod. 7840

Mille_W1 | Wall Lights | 220-240 V | topLED 20 W 500 mA

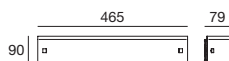

type

White	Nickel	7842
White	Cherry W	

colour

3000 K 2520 lm

optics

diffused



sandblasted glass
nicke_cherry wood detail
cod. 7842

Mille_W1 | Wall Lights | 220-240 V | topLED 28 W 700 mA

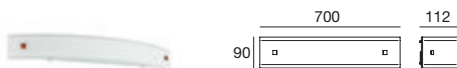

type		colour	optics
White	Nickel	3000 K	diffused
7844		3512 lm	
White	Cherry W		



sandblasted glass
nickel_cherry wood detail
cod. 7844

Mille_W1 | Wall Lights | 220-240 V | stripLED 34 W 1000 mA



type		colour	optics
White	Nickel	3000 K	diffused
7846		4200 lm	
White	Cherry W		



sandblasted glass
nickel_cherry wood detail
cod. 7846

Mille_W1 | Wall Lights | 220-240 V | stripLED 34 W 500 mA



type		colour	optics
White	Nickel	3000 K	diffused
7848		4200 lm	
White	Cherry W		



sandblasted glass
nickel_cherry wood detail
cod. 7848

Mille_W2 | Wall Lights | 220-240 V | topLED 14 W 500 mA



type		colour	optics
White	Nickel	3000 K	diffused
7850		1680 lm	
White	Cherry W		



sandblasted glass
nickel_cherry wood detail
cod. 7850

Mille_P | Pendant Luminaires | 220-240 V | 1xE27

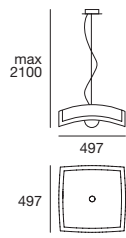
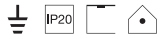

type

White **1017**

source

1x77W Max

optics

diffused

Mille_P | Pendant Luminaires | 220-240 V | 1xE27

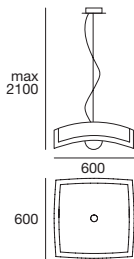

type

White **1018**

source

1x77W Max

optics

diffused

Mille_SQ | Ceiling Lights | 220-240 V | 2xE27

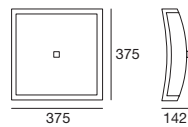

type

White Nickel **3568**

source

2x46W Max

optics

diffused



sandblasted glass
nickel detail
cod. 3568

Mille_SQ | Ceiling Lights | 220-240 V | 3xE27

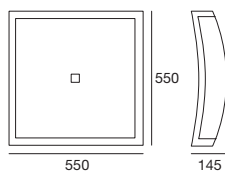

type

White Nickel **3569**

source

3x30W Max

optics

diffused



sandblasted glass
nickel detail
cod. 3569

Mille_SB | Ceiling Lights | 220-240 V | 2xE27

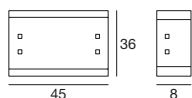

type		source	optics
White	Nickel	1010	2x46W Max

White	Nickel	1040
White	Cherry W	

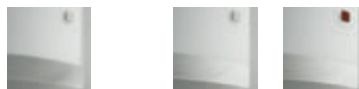

transparent glass
nickel detail
cod. 1010

sandblasted glass
nickel_cherry wood detail
cod. 1040

Mille_SB | Ceiling Lights | 220-240 V | 3xE27

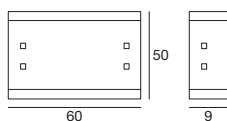

type		source	optics
White	Nickel	1011	3x46W Max

White		1041
White	Cherry W	

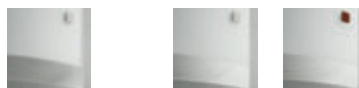

transparent glass
nickel detail
cod. 1011

sandblasted glass
nickel_cherry wood detail
cod. 1041

Mille_W1 | Wall Lights | 220-240 V | 1xG9

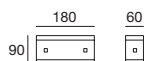

type		source	optics
White	Nickel	6845	Halogen 1x33 W (included)

White	Nickel	6846
White	Cherry W	

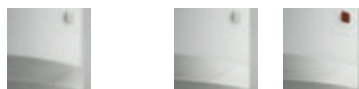

transparent glass
nickel detail
cod. 6845

sandblasted glass
nickel_cherry wood detail
cod. 6846

Mille_W1 | Wall Lights | 220-240 V | 1xR7s

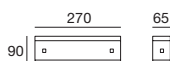
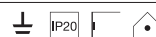

type		source	optics
White	Nickel	1002	Halogen 1x80 W (included)

White	Nickel	1022
White	Cherry W	

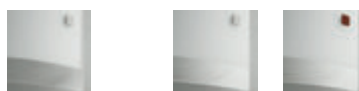

transparent glass
nickel detail
cod. 1002

sandblasted glass
nickel_cherry wood detail
cod. 1022

Mille_W1 | Wall Lights | 220-240 V | 1xR7s

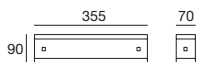

type

White Nickel **1003**

White Nickel **1023**

White Cherry W

source

Halogen 1x120 W (included)

optics

diffused



transparent glass
nickel detail
cod. 1003



sandblasted glass
nickel_cherry wood detail
cod. 1023

Mille_W1 | Wall Lights | 220-240 V | 1xR7s

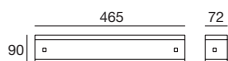
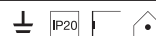

type

White Nickel **1004**

White Nickel **1024**

White Cherry W

source

Halogen 1x120 W (included)

optics

diffused



transparent glass
nickel detail
cod. 1004



sandblasted glass
nickel_cherry wood detail
cod. 1024

Mille_W2 | Wall Lights | 220-240 V | 1xE27

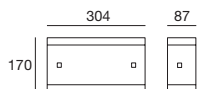
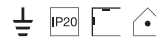

type

White Nickel **1015**

White Nickel **1045**

White Cherry W

source

1x46W Max

optics

diffused



transparent glass
nickel detail
cod. 1015



sandblasted glass
nickel_cherry wood detail
cod. 1045

Mille_W2 | Wall Lights | 220-240 V | 1xR7s

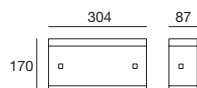

type

White Nickel **1005**

White Nickel **1025**

White Cherry W

source

Halogen 1x120 W (included)

optics

diffused



transparent glass
nickel detail
cod. 1005



sandblasted glass
nickel_cherry wood detail
cod. 1025



upgraded

CURVÉ /

Home Lighting 1.0_indoor



CURVÉ WALL LAMPS





Curvè | A wall light with a curved casing and a double emission that decorates every wall with style.

Materials: white wrinkle-effect or corten or beton light grey coated aluminium casing; white satin-finished polymethylmethacrylate diffuser.

Curvè | Wall Lights | 220-240 V | topLED 15 W 350 mA



type

White	CRI 90	1140
Cor-Ten	CRI 90	1141
Concrete	CRI 90	1146

colour

3000 K 1813 lm

optics

diffused

Curvè | Wall Lights | 220-240 V | topLED 30 W 700 mA

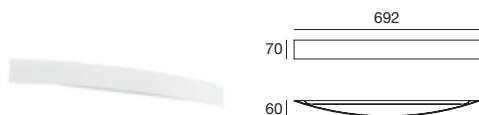

type

White	CRI 90	1143
Cor-Ten	CRI 90	1144
Concrete	CRI 90	1147

colour

3000 K 3625 lm

optics

diffused

Curvè | Wall Lights | 220-240 V | topLED 35 W 900 mA

new

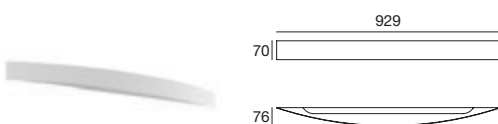

type

White	CRI 90	1190
Cor-Ten	CRI 90	1191
Concrete	CRI 90	1192

colour

3000 K 4536 lm

optics

diffused

Curvè | Wall Lights | 220-240 V | 1xR7s



90 | $\frac{270}{\text{---}}$ $\frac{60}{\text{---}}$

type

White **1135**
 Nickel **1030**

source

Halogen 1x80 W (included)

optics

diffused

Curvè | Wall Lights | 220-240 V | 1xR7s



80 | $\frac{395}{\text{---}}$ $\frac{76}{\text{---}}$

type

White **1131**
 Nickel **1031**

source

Halogen 1x120 W (included)

optics

diffused

Curvè | Wall Lights | 220-240 V | 1xR7s



80 | $\frac{510}{\text{---}}$ $\frac{80}{\text{---}}$

type

White **1136**
 Nickel **1032**

source

Halogen 1x120 W (included)

optics

diffused



HELI /



HELI WALL LIGHTS



Heli | An ellipse releases its light energy along the wall, for a wall light that is elegant in its simplicity.

Materials: mounting frame made of polished aluminium or of coated aluminium with white wrinkle-effect, antique brown, sablè grey or gold-leaf effect finish; white satin-finished polymethylmethacrylate diffuser.

Heli | Wall Lights | 220-240 V | topLED 21 W 500 mA

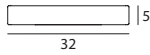
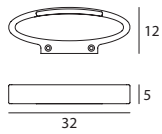

type

White	CRI 90	8455
Alumin.	CRI 90	8456
Sablè	CRI 90	8457
Brown	CRI 90	8458
Gold	CRI 90	8459

colour

3000 K 1976 lm

optics

diffused



accessories



KIT0026

Phase-cut
Dimmer



CONUS /



^ CONUS CEILING LIGHTS
< CONUS PENDANT LUMINAIRES



CONUS PENDANT LUMINAIRES



CONUS CEILING LIGHTS



CONUS CEILING LIGHTS



CONUS FLOOR LAMPS



CONUS TABLE LAMPS

Conus | From the union of an elegant, cone-shaped screen, and the LED technology, comes a table luminaire or floor lamp that furnishes the room with style and discretion.

Materials: white or black wrinkle-effect coated aluminium casing; white sandblasted glass diffuser.

Conus_P1 | Pendant Luminaires | 220-240 V | arrayLED 6 W 120 mA

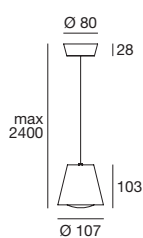

type

White	CRI 90	7248
Black	CRI 90	7530

colour

3000 K 608 lm

optics

diffused

Conus_P1 | Pendant Luminaires | 220-240 V | topLED 7 W 350 mA

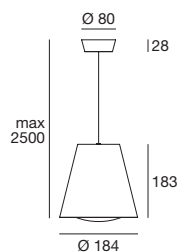

type

White	CRI 90	7254
Black	CRI 90	7532

colour

3000 K 907 lm

optics

diffused

Conus_P2 | Pendant Luminaires | 220-240 V | topLED 21 W 500 mA

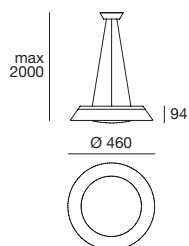

type

White	CRI 90	7275
Black	CRI 90	7538

colour

3000 K 2560 lm

optics

diffused

Conus_S1 | Ceiling Lights | 220-240 V | arrayLED 6 W 120 mA

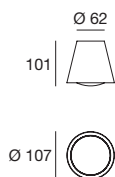

type

White	CRI 90	7251
Black	CRI 90	7531

colour

3000 K 605 lm

optics

diffused

Conus_S1 | Ceiling Lights | 220-240 V | topLED 7 W 350 mA

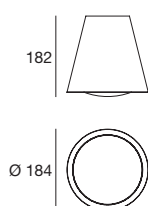

type

White	CRI 90	7257
Black	CRI 90	7533

colour

3000 K 907 lm

optics

diffused

Conus_S2 | Ceiling Lights | 220-240 V | topLED 19 W 500 mA

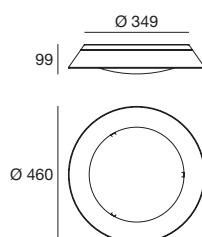

type

White	CRI 90	7272
Black	CRI 90	7537

colour

3000 K 2364 lm

optics

diffused

Conus_S3 | Ceiling Lights | 220-240 V | topLED 2 W 500 mA

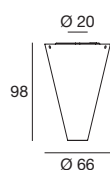

type

White	CRI 90	7287
Black	CRI 90	7542

colour

3000 K 90 lm

optics

70°

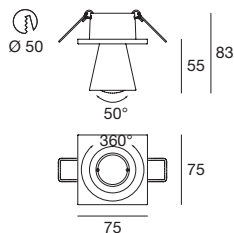
Conus_C | Downlights | 220-240 V | topLED 2 W 500 mA**type**

White	CRI 90	7269
Black	CRI 90	7536

colour

3000 K 200 lm

optics

diffused

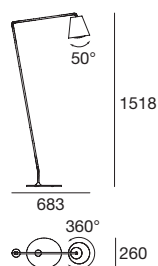
electronics**KIT72**ON/OFF
Driver
1-10 art.**Conus_FL** | Floor Lamps | 220-240 V | topLED 7 W 350 mA**type**

White	CRI 90	7284
Black	CRI 90	7541

colour

3000 K 907 lm

optics

diffused

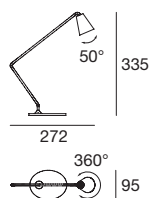
Conus_tab | Table Lamps | 220-240 V | topLED 2 W 500 mA**type**

White	CRI 90	7278
Black	CRI 90	7280

colour

3000 K 200 lm

optics

diffused

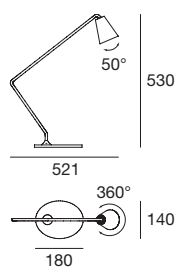
Conus_tab | Table Lamps | 220-240 V | arrayLED 6 W 120 mA**type**

White	CRI 90	7281
Black	CRI 90	7540

colour

3000 K 605 lm

optics

diffused



SNAKE /



^ SNAKE WALL LIGHTS
< SNAKE CEILING LIGHTS

SNAKE WALL LIGHTS





SNAKE FLOOR LAMPS



Snake | A sinuous snake faces outwards from the wall or the ceiling, illuminating moments of intimacy with absolute discretion, observing curiously in every direction.

Materials: white or black wrinkle-effect coated metal base; white or matt black santropene tube; sandblasted polycarbonate diffuser. Natural cement base in the standing lamp version.

Snake_S | Ceiling Lights | 220-240 V | topLED 19 W 500 mA

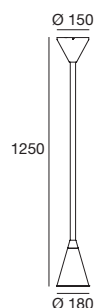
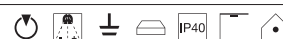

type

White	CRI 90	7859
Black	CRI 90	7860

colour

3000 K 2182 lm

optics

diffused

accessories



KIT0026

Phase-cut Dimmer

Snake_W1 | Wall Lights | 220-240 V | topLED 2 W 500 mA



type

White	CRI 90	7223
Black	CRI 90	7224

colour

3000 K 200 lm

optics

diffused

electronics



KIT72

ON/OFF Driver



KIT73

ON/OFF Driver

Snake_W1 | Wall Lights | 220-240 V | topLED 2 W 500 mA

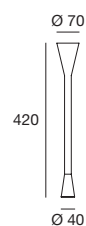

type

White	CRI 90	7220
Black	CRI 90	7221

colour

3000 K 200 lm

optics

diffused

Snake_W1 | Wall Lights | 220-240 V | topLED 2 W 500 mA

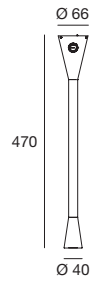

type

White	CRI 90	7232
Black	CRI 90	7233

colour

3000 K 200 lm

optics

diffused

Snake_W2 | Wall Lights | 220-240 V | topLED 2 W 500 mA

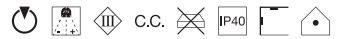

type

White	CRI 90	7229
Black	CRI 90	7230

colour

3000 K 200 lm

optics

diffused

electronics



KIT72
ON/OFF
Driver

KIT73
ON/OFF
Driver

Snake_W3 | Wall Lights | 220-240 V | topLED 2 W 500 mA

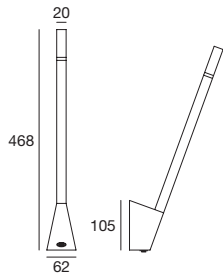

type

White	CRI 90	7234
Black	CRI 90	7235

colour

3000 K 200 lm

optics

diffused

Snake_W3 | Wall Lights | 220-240 V | topLED 2 W 500 mA

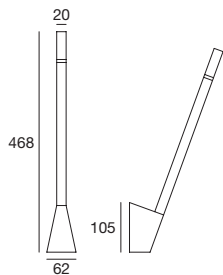

type

White	CRI 90	7226
Black	CRI 90	7227

colour

3000 K 200 lm

optics

diffused

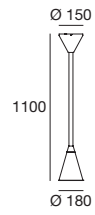
Snake_W4 | Wall Lights | 220-240 V | topLED 19 W 500 mA**type**

White	CRI 90	7857
Black	CRI 90	7858

colour

3000 K 2182 lm

optics

diffused

accessories**KIT0026**Phase-cut
Dimmer**Snake_FL** | Floor Lamps | 220-240 V | topLED 19 W 500 mA**type**

White	CRI 90	7861
Black	CRI 90	7862

colour

3000 K 2182 lm

optics

diffused



BART /

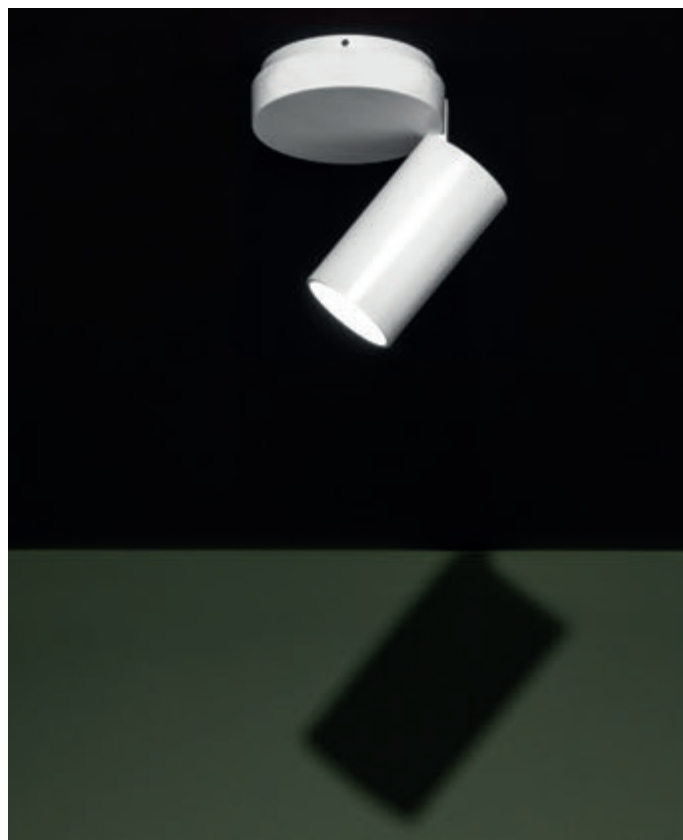

BART CEILING LIGHTS



BART CEILING LIGHTS

Bart | An aluminium spotlight with smart, refined lines to rediscover the shapes and details of particular interiors, highlighting key areas of an interior through light.

Materials: white or black wrinkle-effect coated aluminium casing; transparent polycarbonate diffuser.

Bart_S | Ceiling Lights | 220-240 V | arrayLED 11 W 250 mA

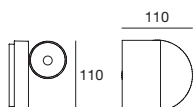

type

White	CRI:90	8466
Black	CRI:90	8467

colour

3000 K 1162 lm

optics

45°

accessories



KIT0026
Phase-cut Dimmer



Bart_W | Wall Lights | 220-240 V | arrayLED 5 W 120 mA

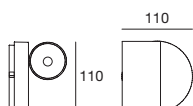

type

White	CRI:90	7956
Black	CRI:90	7957

colour

3000 K 605 lm

optics

45°





ONE TO ONE /



ONE TO ONE CEILING LIGHTS

One to One | A luminous disk detaches from the ceiling with curiosity, illuminating wherever it is directed.

Materials: white wrinkle-effect coated aluminium mounting frame; sandblasted polymethylmethacrylate diffuser.

One to One_S | Ceiling Lights | 220-240 V | 1 x powerLED 10 W 500 mA

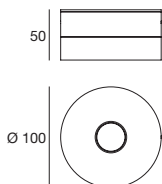

type

White	CRI 90	7618
Chrome	CRI 90	7640
Copper	CRI 90	7641

colour

3000 K 1162 lm

optics

60°

accessories



KIT0026

Phase-cut Dimmer

One to One_C | Downlights | 1 x powerLED 10 W 500 mA

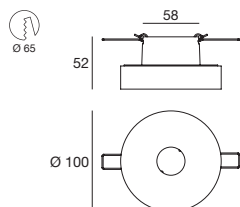

type

White	CRI 90	7619
Chrome	CRI 90	7642
Copper	CRI 90	7643

colour

3000 K 1162 lm

optics

60°

electronics



KIT0064

Phase-cut 1 art.

KIT0065

Phase-cut 2-3 art.

accessories



KIT0026

Phase-cut Dimmer



BEEBO /



^ BEEBO WALL LIGHTS
< BEEBO CEILING LIGHTS



BEEBO WALL LIGHTS

Beebo | Imaginative and versatile, it is ideal to create evocative interplays of light and shadows and drive the gaze to the details embellishing an interior.

Materials: casing in white or black wrinkle-effect coated aluminium or with a oak wood cover; transparent polycarbonate diffuser.

Beebo_S | Ceiling Lights | 220-240 V | topLED 11 W 250 mA



type

White	CRI 90	8460
Black	CRI 90	8461
Oak W.	CRI 90	8462

colour

3000 K 1162 lm

optics

45°

accessories



KIT0026

Phase-cut Dimmer

Beebo_W | Wall Lights | 220-240 V | arrayLED 5 W 120 mA

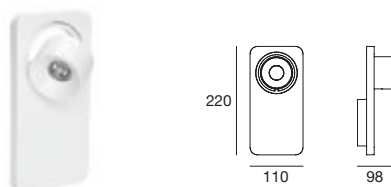

type

White	CRI 90	7972
Black	CRI 90	7973
Oak W.	CRI 90	7974

colour

3000 K 605 lm

optics

45°



INCASSO /



INCASSO DOWNLIGHTS



INCASSO DOWNLIGHTS

Incasso | Flush mounted spotlights in ceilings with functional light, easily integrated in any environment. Minimal design for complete integration or decorative and multi-faceted.

Materials: housing in textured white painted aluminium with recessed optics or with transparent or black glass diffuser.

Incasso_C1 | Downlights | 220-240 V | 1xGU10

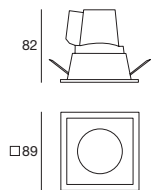

new



type

White	CRI 80	8375
Black	CRI 80	8376

source

1x42 W Max

optics

diffused

Incasso_C2 | Downlights | 220-240 V | 1xGU10

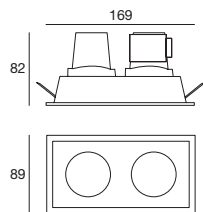

new



type

White	CRI 80	8379
Black	CRI 80	8380

source

2x42 W Max

optics

diffused

Incasso_CJ1 | Downlights | 220-240 V | 1xGU10

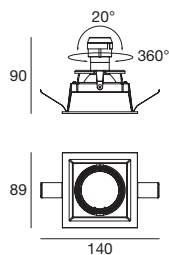

new



type

White	CRI 80	8369
Black	CRI 80	8370

source

1x42 W Max

optics

diffused

Incasso_CJ2 | Downlights | 220-240 V | 2xGU10

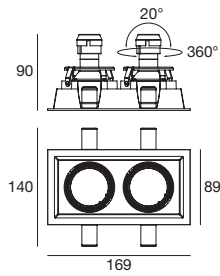

new



type

White CRI 80 **8372**
 Black CRI 80 **8373**

source

2x42 W Max

optics

diffused

Incasso_1 | Downlights | 220-240 V | 1xGU5,3

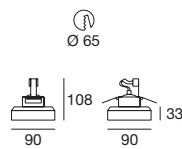

type

Transp. **6360**

source

1x50W Max

optics

diffused

electronics



KIT86
ON/OFF

Incasso_2 | Downlights | 220-240 V | 1xGU5,3

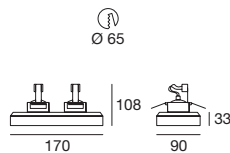

type

Transp. **6361**

source

1x50W Max

optics

diffused

electronics



KIT86
ON/OFF

Incasso_R | Downlights | 220-240 V | 1xGU5,3

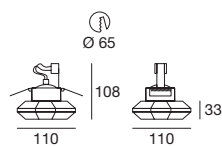

type

Transp. **6364**

source

1x50W Max

optics

diffused

electronics



KIT86
ON/OFF

1999

1999



new

Home Lighting 1.0_indoor

GYPSUM_CELL /



GYPSUM_CELL DOWNLIGHTS

GYPSUM_CELL DOWNLIGHTS



Gypsum_Cell | Flush recessed adjustable spot, available in three direct light options: rectangular 3 or 6 spots, squared 9 spots. Chalk invisible frame, customizable finishes. Perfect for accent lighting. Magnetic locking, set back and shade LED source.

Gypsum_Cell1 | Downlights | 3 x powerLEDs 2 W | 6 W 700 mA

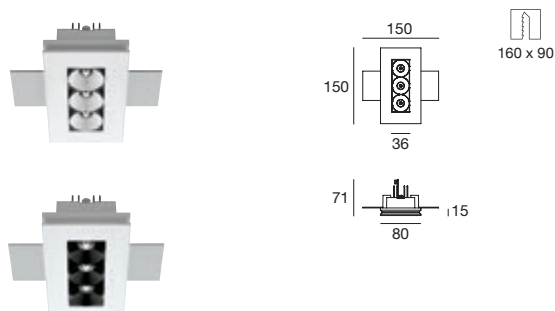

new



type	colour			optics	
White 64547	CRI 90	3000 K	747 lm	W	15° 15
Black 64546	CRI 80	4000 K	795 lm	N	30° 30

electronics



62437
ON/OFF
1 art.



62439
ON/OFF
3-4 art.



99115
1-10V/PUSH
1-3 art.



99114
DALI/PUSH
1-3 art.



99344
DALI/PUSH
1-4 art.



60830
Shim

accessories

Gypsum_Cell2 | Downlights | 6 x powerLEDs 2 W | 12 W 700 mA

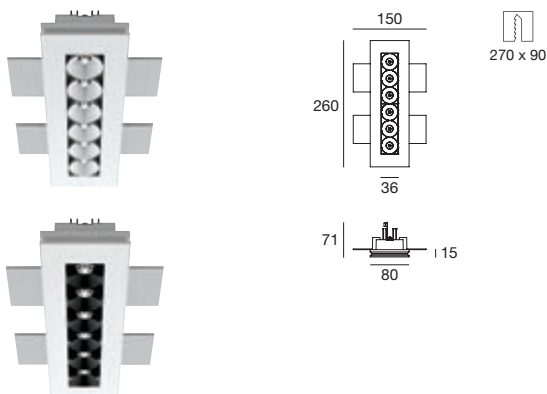

new



type	colour			optics	
White 64549	CRI 90	3000 K	1494 lm	W	15° 15
Black 64548	CRI 80	4000 K	1590 lm	N	30° 30

electronics



62438
ON/OFF
1 art.



62439
ON/OFF
1-2 art.



99115
1-10V/PUSH
1 art.



99114
DALI/PUSH
1 art.



99344
DALI/PUSH
1-2 art.



60830
Shim

accessories

Gypsum_Cell3 | Downlights | 9 x powerLEDs 2 W | 18 W 700 mA

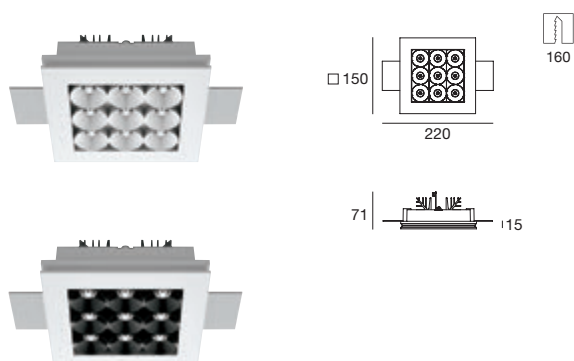

new



type	colour			optics	
White 64551	CRI 90	3000 K	2241 lm	W	15° 15
Black 64550	CRI 80	4000 K	2385 lm	N	30° 30

electronics



62439
ON/OFF
1 art.



99115
1-10V/PUSH
1 art.



99114
DALI/PUSH
1 art.



60830
Shim

accessories



GYPSUM_R_O_EYE_ILL /



^ GYPSUM_O DOWNLIGHTS
< GYPSUM_O DOWNLIGHTS



GYP SUM_O DOWNLIGHTS



GYPSUM_ILL DOWNLIGHTS





Gypsum_R_O | The plasticity of gypsum blends the lighting fixture with the construction elements that define the space. Light, matter and colour become a whole that can be radically renovated thanks to the paintable surface of Gypsum. A real white canvas that you can customize based on your own taste.

Gypsum_Eye | Downlights with great performances, the concave chalk surface cloaks light source and softens the light. Available with special lens for special lighting effects, diffusive or concentrate.

Gypsum_III | Available in three flush versions: organic, square and rectangular module. The suggested options guarantee highest flexibility for a better lighting effects management.

Gypsum_R1 | Downlights | arrayLED 7,5 W 200 mA

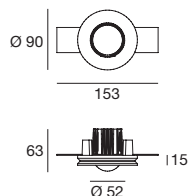

100

type

White CRI 80 **61350**

colour

3000 K 1117 lm **W**

4000 K 1153 lm **N**

optics

70° **70**

electronics



62423

ON/OFF
1 art.

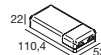

62431

1-10V/PUSH
1 art.



62432

DALI/PUSH
1 art.



accessories



60830

Shim



61360

Outer casing

Gypsum_R2 | Downlights | arrayLED 7,5 W 200 mA

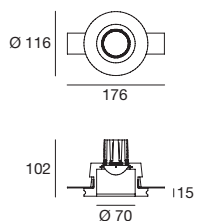

126

type

White CRI 80 **61330**

colour

3000 K 1117 lm **W**

4000 K 1153 lm **N**

optics

70° **70**

electronics



62423

ON/OFF
1 art.

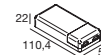

62431

1-10V/PUSH
1 art.



62432

DALI/PUSH
1 art.



accessories



60830

Shim



60860

Glass

Gypsum_R3 | Downlights | arrayLED 18 W 500 mA

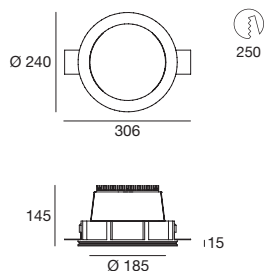
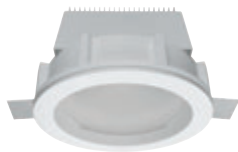

type

White | CRI 80 | **62660**

colour

3000 K | 2611 lm | **W**
4000 K | 2697 lm | **N**

optics

diffused | **00**

electronics

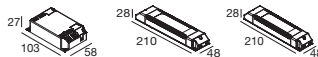

99106 ON/OFF 1 art.
99115 1-10V/PUSH 1 art.
99114 DALI/PUSH 1 art.

accessories



60830
Shim

Gypsum_R1 | Downlights | 1xGU10

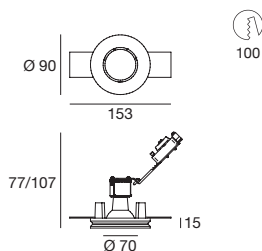

type

White | **61250**

source

1xGU10 35W Max

optics

variable

accessories

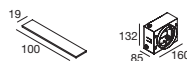

60830 Shim
61360 Outer casing

Gypsum_R2 | Downlights | 1xGU10

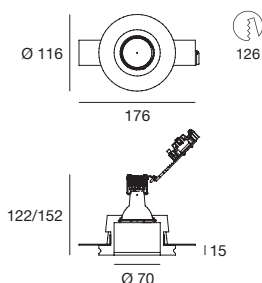

type

White | **61230**

source

1xGU10 35W Max

optics

variable

accessories

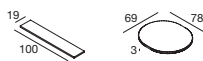

60830 Shim
60860 Glass

Gypsum_O1 | Downlights | arrayLED 7,5 W 200 mA

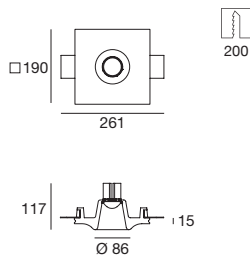

type

White CRI 80 **60801**

colour

3000 K 1117 lm **W**
4000 K 1153 lm **N**

optics

70° **70**

electronics



62423
ON/OFF
1 art.

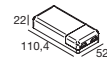

62431
1-10V/PUSH
1 art.

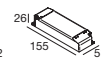

62432
DALI/PUSH
1 art.



accessories



60830
Shim

Gypsum_O2 | Downlights | arrayLED 7,5 W 200 mA

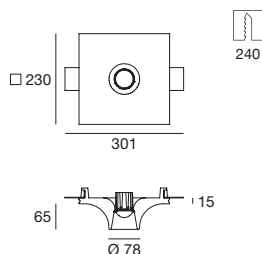

type

White CRI 80 **60821**

colour

3000 K 1117 lm **W**
4000 K 1153 lm **N**

optics

70° **70**

electronics



62423
ON/OFF
1 art.

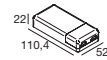

62431
1-10V/PUSH
1 art.

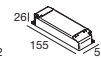

62432
DALI/PUSH
1 art.



accessories



60830
Shim

Gypsum_O3 | Downlights | arrayLED 18 W 500 mA

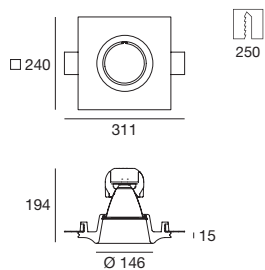

type

White CRI 80 **60824**

colour

3000 K 2611 lm **W**
4000 K 2697 lm **N**

optics

45° **45**

electronics



99106
ON/OFF
1 art.

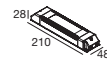

99115
1-10V/PUSH
1 art.

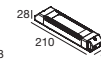

99114
DALI/PUSH
1 art.

accessories



60830
Shim

Gypsum_O4 | Downlights | arrayLED 18 W 500 mA

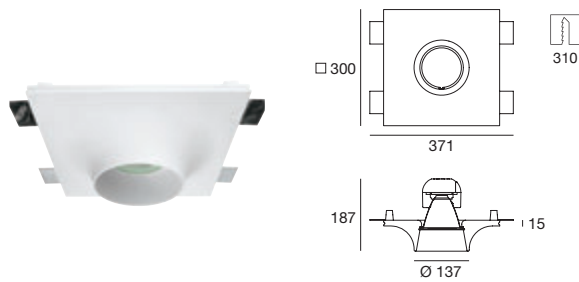

type		colour			optics	
White	CRI 80 60827	3000 K	2611 lm	W	45°	45
		4000 K	2697 lm	N		

electronics

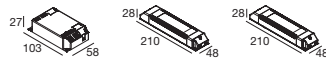

99106	99115	99114
ON/OFF	1-10V/PUSH	DALI/PUSH
1 art.	1 art.	1 art.

accessories



60830
Shim

Gypsum_O1 | Downlights | 1xGU10

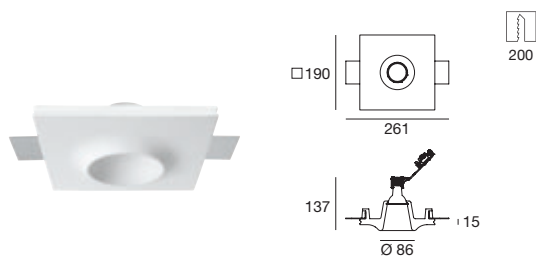

type		source	optics
White	60802	1x35 W	variable

accessories



60830
Shim

Gypsum_O2 | Downlights | 1xGU10

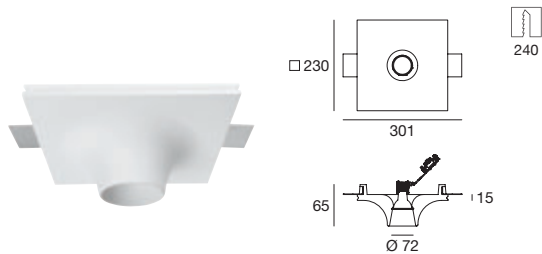

type		source	optics
White	60822	1x35 W	variable

accessories



60830
Shim

Gypsum_Eye1 | Downlights | arrayLED 7,5 W 200 mA

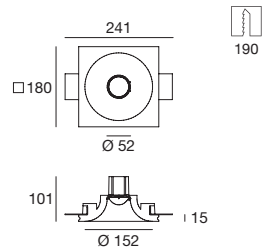

type		colour		optics	
White	CRI 80 61340	3000 K	1117 lm	W	70°
		4000 K	1153 lm	N	70

electronics

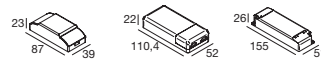

62423	62431	62432
ON/OFF	1-10V/PUSH	DALI/PUSH
1 art.	1 art.	1 art.



accessories



60830
Shim

Gypsum_Eye2 | Downlights | arrayLED 12,5 W 350 mA

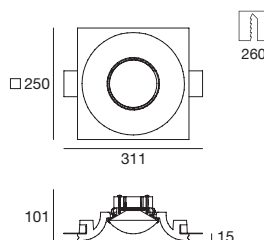

type		colour		optics	
White	CRI 80 60852	3000 K	1876 lm	W	50°
		4000 K	1938 lm	N	50

electronics

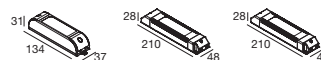

99126	99115	99114
ON/OFF	1-10V/PUSH	DALI/PUSH
1 art.	1 art.	1 art.

accessories



60830
Shim

Gypsum_Eye3 | Downlights | arrayLED 12,5 W 350 mA

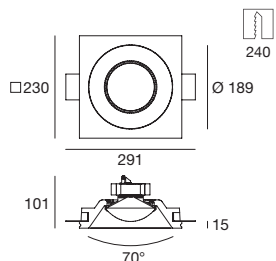

type		colour		optics	
White	CRI 80 60853	3000 K	1876 lm	W	50°
		4000 K	1938 lm	N	50

electronics

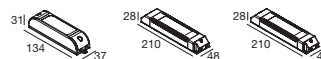

99126	99115	99114
ON/OFF	1-10V/PUSH	DALI/PUSH
1 art.	1 art.	1 art.

accessories



60830
Shim

Gypsum_Eye4 | Downlights | 110-240 V | topLED 21 W

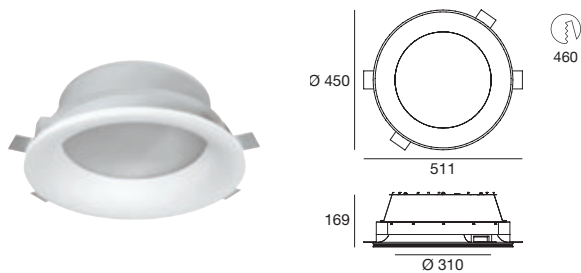

type

White CRI 80 **60828**

colour

3000 K 2180 lm **W**
4000 K 2304 lm **N**

optics

diffused **00**

accessories



60830

Shim

Gypsum_Eye1 | Downlights | 1xGU10

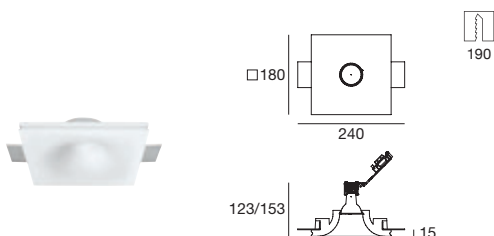

type

White **60980**

source

1x35 W

optics

variable

accessories



60830

Shim

Gypsum_EyeJ | Downlights | 1xG53

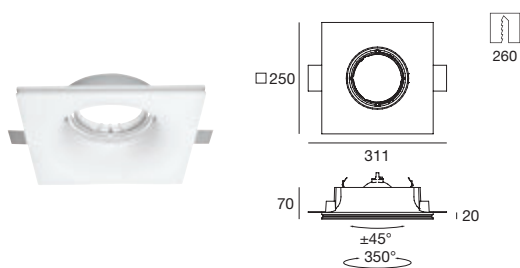

type

White **61370**

source

1x65 W

optics

diffused

Suggested electronics

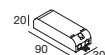

57350

ON/OFF
1 art.

accessories



60830

Shim

Gypsum_III1 | Downlights |

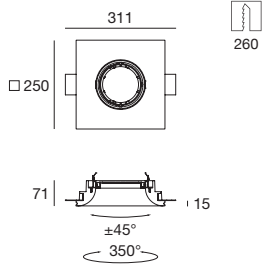

type

White **60843**

accessories

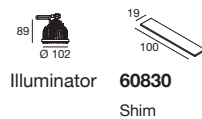

Gypsum_III2 | Downlights |

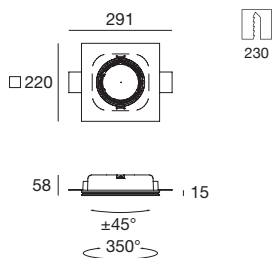

type

White **60844**

accessories

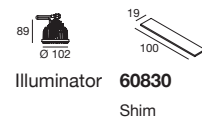

Gypsum_III3 | Downlights |

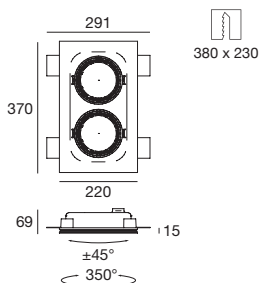

type

White **60845**

accessories

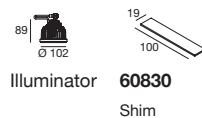

Illuminator_1 | Downlights | arrayLED 15 W 400 mA

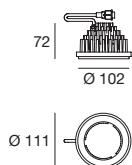

type		colour			optics	
White	CRI 95	97476	3000 K	1414 lm	W	30° 30
			4000 K	1522 lm	N	60° 60
White	CRI 80	97482	3000 K	1875 lm	W	30° 30
			4000 K	2013 lm	N	60° 60

Suggested electronics

accessories



99113
ON/OFF
1 art.

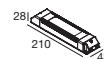

99116
1-10V/PUSH
1 art.

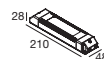

99131
DALI/PUSH
1 art.



98071
30° Optics



98072
60° Optics

Illuminator_2 | Downlights | arrayLED 25 W 720 mA

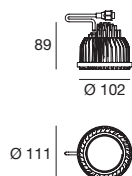

type		colour			optics	
White	CRI 95	97485	3000 K	2511 lm	W	30° 30
			4000 K	2695 lm	N	60° 60
White	CRI 80	97491	3000 K	3321 lm	W	30° 30
			4000 K	3568 lm	N	60° 60

electronics

accessories



99112
ON/OFF
1 art.

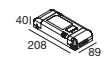

99188
1-10V, DALI
PUSH
1 art.

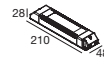

99330
DALI/PUSH
1 art.



98071
30° Optics



98072
60° Optics

Illuminator_3 | Downlights | arrayLED 30 W 840 mA

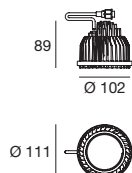
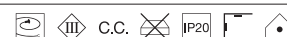

type		colour			optics	
White	CRI 95	91229	3000 K	2839 lm	W	15° 15
			4000 K	3261 lm	N	30° 30
						60° 60
White	CRI 80	91232	3000 K	3945 lm	W	15° 15
			4000 K	3945 lm	N	30° 30
						60° 60

electronics

accessories



99093
ON/OFF
1 art.



99187
1-10V, DALI
PUSH
1 art.

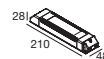

99330
DALI
1 art.



98507
15° Optics



98508
30° Optics



98509
60° Optics



GYPSUM_Q_D_S /



^ GYPSUM_SR DOWNLIGHTS
< GYPSUM_QRD DOWNLIGHTS







GYPSUM_DX DOWNLIGHTS



GYPSUM_QD DOWNLIGHTS

Gypsum_Q | Square compact shapes fitted. Versatile for all designers and spaces lighting needs. A quality detail with a timeless design.

Gypsum_D | Light figure available in many options: squared and rectangular. Combinable in free and mixed geometry, ideal for illuminating path and passages, with a soft and without contrasts light. Invisible frame and source, the light flows directly from the surface.

Gypsum_S | Two complementary shapes, easily combinable, minimum dimensions. Semi recessed solution allows products concealing in the living space. The chalk frame, allows a perfect integration with the installing and finish surface, and lighting source shielding to maximize the visual comfort, hiding the lamp.

Gypsum_QC1 | Downlights | 1 x powerLED 1,5 W 500 mA

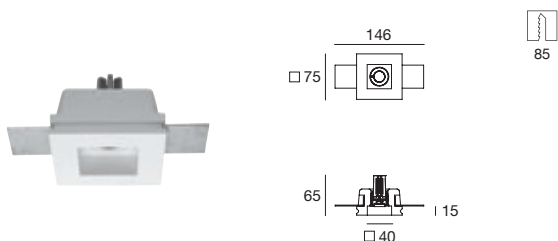

type		colour		optics	
White	CRI 80 64500	3000 K	144 lm	W	60°
		4000 K	180 lm	N	60

Suggested electronics

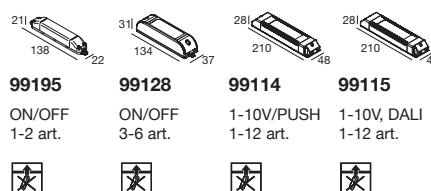

accessories

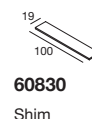

Gypsum_QC2 | Downlights | arrayLED 7,5 W 200 mA

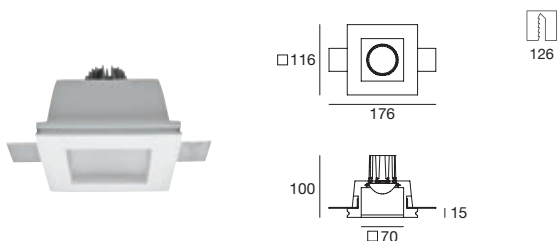

type		colour		optics	
White	CRI 80 60990	3000 K	1117 lm	W	70°
		4000 K	1153 lm	N	70

electronics

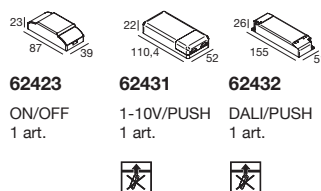

accessories

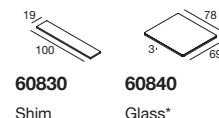

Gypsum_QC2 | Downlights | 1xGU10

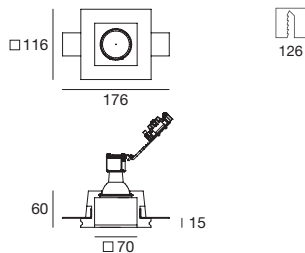

type	source	optics
White 61210	1x35 W	variable

accessories

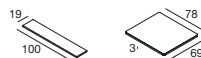

60830	60840
Shim	Glass*

Gypsum_QC3 | Downlights | 2 x arrayLED 7,5 W 200 mA

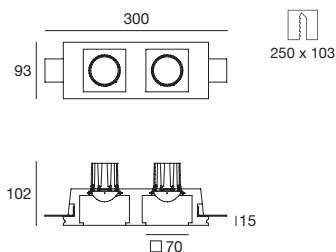

type	colour	optics
White CRI 80 61800	3000 K 2x1117 lm W 4000 K 2x1153 lm N	70° 70

Suggested electronics
2 driver per article

accessories

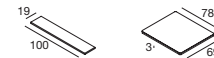
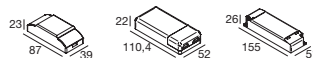

62423	62431	62432	60830	60840
ON/OFF 2 x 62423	1-10V/PUSH 2 x 62431	DALI/PUSH 2 x 62432	Shim	Glass*



Gypsum_QC3 | Downlights | 2xGU10

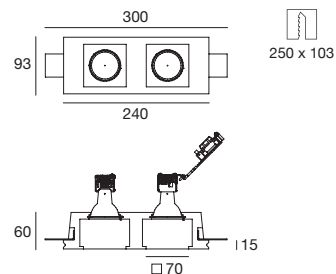

type	source	optics
White 62480	35 W Max	variable

accessories

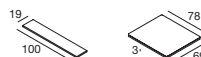

60830	60840
Shim	Glass*

Gypsum_QC4 | Downlights | arrayLED 7,5 W 200 mA

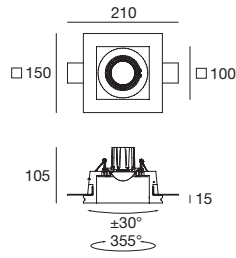

type

White CRI 80 **60595**

colour

3000 K 1117 lm **W**
4000 K 1153 lm **N**

optics

70° **70**

electronics



62423
ON/OFF
1 art.



62431
1-10V/PUSH
1 art.

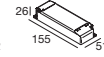

62432
DALI/PUSH
1 art.

accessories



60830
Shim

Gypsum_QCY | Downlights | arrayLED 7,5 W 200 mA

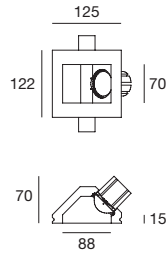

type

White CRI 80 **61410**

colour

3000 K 1117 lm **W**
4000 K 1153 lm **N**

optics

70° **70**

electronics



62423
ON/OFF
1 art.



62431
1-10V/PUSH
1 art.

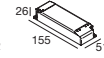

62432
DALI/PUSH
1 art.

accessories



60830
Shim

Gypsum_QC4 | Downlights | 1xGU10

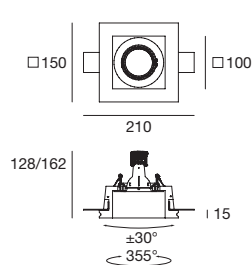

type

White **62430**

source

1x35 W

optics

variable

accessories



60830
Shim

Gypsum_QCY | Downlights | 1xGU10

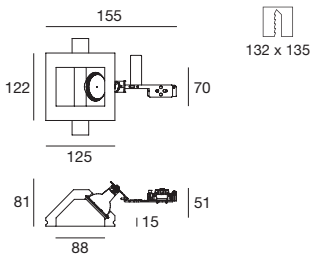

type

White 61320

source

1x35 W

optics

variable

accessories



60830

Shim

Gypsum_QD1 | Downlights | arrayLED 9,3 W 250 mA

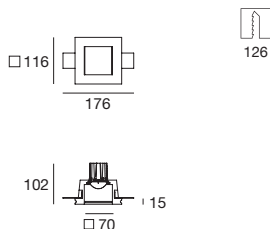

type

White CRI 80 63830

colour

3000 K 1364 lm **W**
4000 K 1408 lm **N**

optics

diffused **00**

electronics



62424

ON/OFF
1 art.



62431

1 art.



62432

1 art.

accessories



60830

Shim

Gypsum_QD2 | Downlights | arrayLED 12,5 W 350 mA

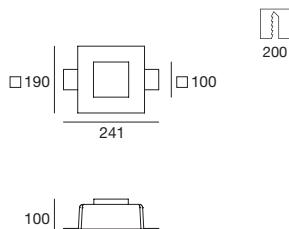

type

White CRI 80 63820

colour

3000 K 1876 lm **W**
4000 K 1938 lm **N**

optics

diffused **00**

Suggested electronics



99126

ON/OFF
1 art.



99114

1-10V/PUSH
1 art.



99115

DALI/PUSH
1 art.

accessories



60830

Shim

Gypsum_QRD | Downlights | arrayLED 7,5 W 200 mA

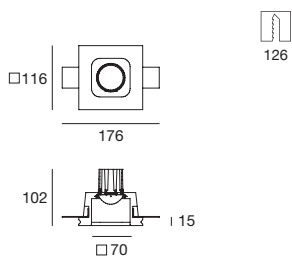

type		colour		optics	
White	CRI 80 61450	3000 K	1117 lm	W	70° 70
		4000 K	1153 lm	N	

electronics

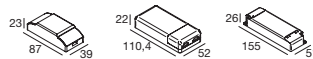

62423	62431	62432
ON/OFF 1 art.	1-10V/PUSH 1 art.	DALI/PUSH 1 art.

accessories

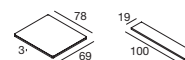

60840	60830
Glass	Shim

Gypsum_QRD | Downlights | 1xGU10

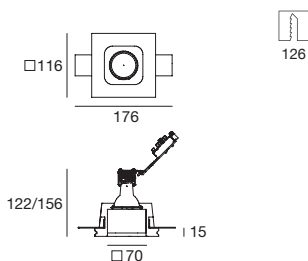

type		source	optics
White	61430	1x35 W	variable

accessories

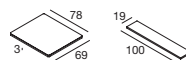

60840	60830
Glass	Shim

Gypsum_D1 | Downlights | 220-240 V | topLED 13 W 350 mA

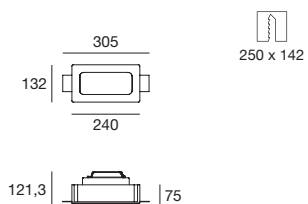
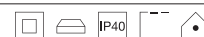

type		colour		optics	
White	CRI 80 64501	3000 K	1610 lm	W	diffused 00

accessories



60830
Shim

Gypsum_D2 | Downlights | 198-264 V | topLED 32 W 900 mA

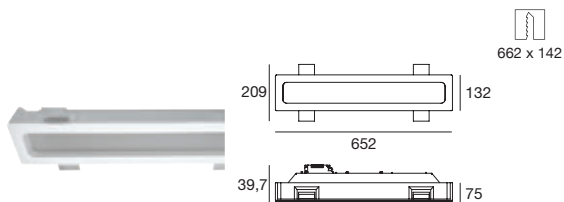

type

White CRI 80 **64502**

colour

3000 K 4140 lm **W**

optics

diffused **00**

accessories



60830

Shim

Gypsum_D3 | Downlights | 198-264 V | topLED 26 W 700 mA

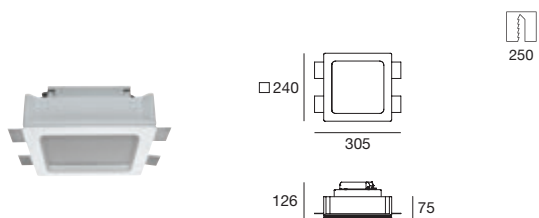

type

White CRI 80 **64504**

colour

3000 K 3220 lm **W**

optics

diffused **00**

accessories



60830

Shim

Gypsum_DX | Downlights | 198-264 V | topLED 51 W 1400 mA

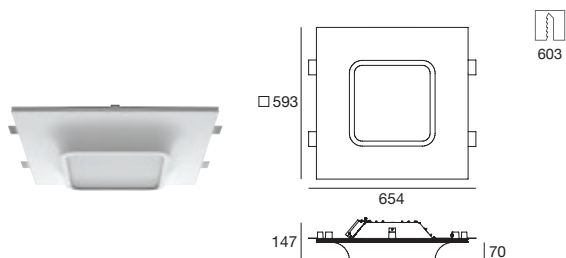

type

White CRI 80 **64503**

colour

3000 K 6440 lm **W**

optics

diffused **00**

accessories



60830

Shim

Gypsum_SR | Downlights | arrayLED 7,5 W 200 mA

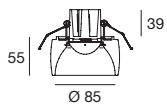

type

White CRI 80 **60851**

colour

3000 K 1117 lm **W**
4000 K 1153 lm **N**

optics

70° **70**

Suggested electronics

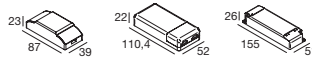

62423

ON/OFF
1 art.

62431

1-10V/PUSH
1 art.

62432

DALI/PUSH
1 art.

Gypsum_SQ | Downlights | arrayLED 7,5 W 200 mA

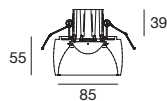

type

White CRI 80 **60848**

colour

3000 K 1117 lm **W**
4000 K 1153 lm **N**

optics

70° **70**

electronics

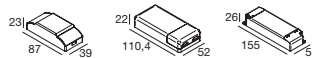

62423

ON/OFF
1 art.

62431

1-10V/PUSH
1 art.

62432

DALI/PUSH
1 art.



GYPSUM_W_WR_WF /



^ GYPSUM_WF RECESSED LIGHTS
< GYPSUM_W WALL LIGHTS

GYPSUM_WR RECESSED LIGHTS





GYPSUM WR RECESSED LIGHTS

Gypsum_W | Essential and minimal rectangular shapes define grazing and soft light beams. The Gypsum series is a traditional material with LED technology combination.

Gypsum_WR_WF | The invisible takes shape, becoming a light source. The invisible frame follows the contemporary architecture needs. This model represents light essence, gathered around a single point. On demand, version with golden or silver leaf inside.

Gypsum_W1 | Wall Lights | 220-240 V | topLED 7,5 W 200 mA

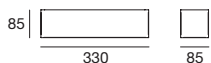

type

White CRI 80 **60834**

colour

3000 K 1104 lm **W**
4000 K 1170 lm **N**

optics

diffused **00**

Gypsum_W2 | Wall Lights | 198-264 V | topLED 15 W 350 mA

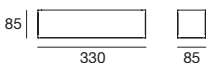

type

White CRI 80 **60817**

colour

3000 K 1927 lm **W**
4000 K 2044 lm **N**

optics

diffused **00**

Gypsum_W3 | Wall Lights | 220-240 V | topLED 25 W 600 mA

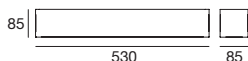

type

White CRI 80 **60819**

colour

3000 K 3315 lm **W**
4000 K 3510 lm **N**

optics

diffused **00**

Gypsum_WX | Wall Lights | 220-240 V | topLED 10 W 500 mA

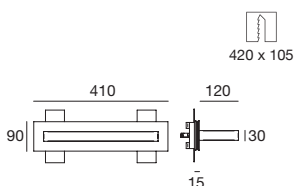

type

White CRI 80 **60816**

colour

3000 K 990 lm **W**
4000 K 1050 lm **N**

optics

diffused **00**

accessories

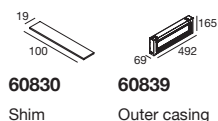

Gypsum_WR1 | Recessed lights | 1 x powerLED 1 W 350 mA

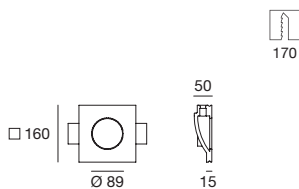

type

White CRI 80 **60813**

colour

3000 K 130 lm **W**
4000 K 140 lm **N**

optics

diffused **00**

electronics

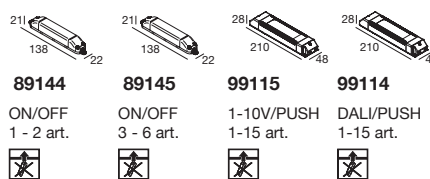

accessories

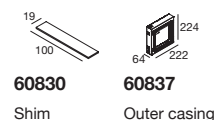

Gypsum_WR2 | Recessed lights | 1 x powerLED 1 W 350 mA

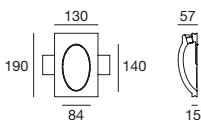

200 x 140

type

White CRI 80 **60815**

colour

3000 K 130 lm **W**
4000 K 140 lm **N**

optics

diffused **00**

electronics

89144	89145	99115	99114
ON/OFF 1 - 2 art.	ON/OFF 3 - 6 art.	1-10V/PUSH 1-15 art.	DALI/PUSH 1-15 art.

accessories

60830	60837
Shim	Outer casing

Gypsum_WRQ | Recessed lights | 1 x powerLED 1 W 350 mA

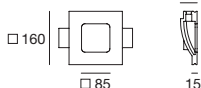

170

type

White CRI 80 **60814**

colour

3000 K 130 lm **W**
4000 K 140 lm **N**

optics

diffused **00**

electronics

89144	89145	99115	99114
ON/OFF 1 - 2 art.	ON/OFF 3 - 6 art.	1-10V/PUSH 1-15 art.	DALI/PUSH 1-15 art.

accessories

60830	60837
Shim	Outer casing

Gypsum_WRX | Recessed lights | 1 x powerLED 1 W 350 mA

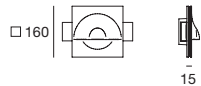

170

type

White CRI 80 **60910**

colour

3000 K 130 lm **W**
4000 K 140 lm **N**

optics

diffused **00**

electronics

89144	89145	99115	99114
ON/OFF 1 - 2 art.	ON/OFF 3 - 6 art.	1-10V/PUSH 1-15 art.	DALI/PUSH 1-15 art.

accessories

60830	60837
Shim	Outer casing

Gypsum_WR3 | Recessed lights | 1 x powerLED 1 W 350 mA

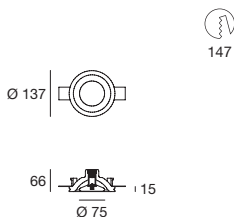

type

White CRI 80 **60811**

colour

3000 K 130 lm **W**
4000 K 140 lm **N**

optics

diffused **00**

electronics

89144	89145	99115	99114
ON/OFF 1 - 2 art.	ON/OFF 3 - 6 art.	1-10V/PUSH 1-15 art.	DALI/PUSH 1-15 art.

accessories

60830	60837
Shim	Outer casing

Gypsum_WF1 | Recessed lights | 1 x powerLED 1 W 350 mA

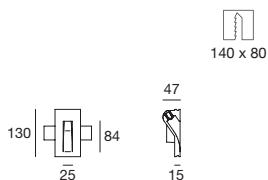

type

White CRI 80 **60920**

colour

3000 K 130 lm **W**
4000 K 140 lm **N**

optics

70° **70**

electronics

89144	89145	99115	99114
ON/OFF 1 - 2 art.	ON/OFF 3 - 6 art.	1-10V/PUSH 1-15 art.	DALI/PUSH 1-15 art.

accessories

60830	61270
Shim	Outer casing

Gypsum_WF2 | Recessed lights | 1 x powerLED 1 W 350 mA

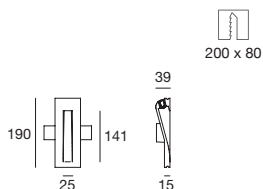

type

White CRI 80 **60930**

colour

3000 K 130 lm **W**
4000 K 140 lm **N**

optics

70° **70**

electronics

89144	89145	99115	99114
ON/OFF 1 - 2 art.	ON/OFF 3 - 6 art.	1-10V/PUSH 1-15 art.	DALI/PUSH 1-15 art.

accessories

60830	61280
Shim	Outer casing

Gypsum_WF3 | Recessed lights | 220-240 V | 1 x powerLED 2 W 500 mA

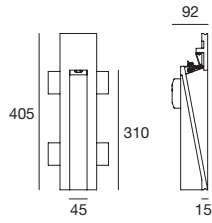

type

White CRI 80 **60680**

colour

3000 K 170 lm **W**
4000 K 180 lm **N**

optics

70° **70**

accessories



60830

Shim



64180

Outer casing

Gypsum_WF4 | Recessed lights | 220-240 V | 4 x powerLED 8 W 500 mA

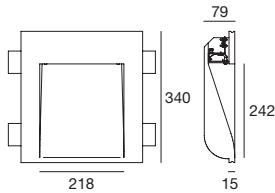

type

White CRI 80 **61390**

colour

3000 K 576 lm **W**
4000 K 720 lm **N**

optics

diffused **00**

accessories



60830

Shim



61290

Outer casing

Gypsum_WF4 | Recessed lights | 220-240 V | 1xGx24q-3

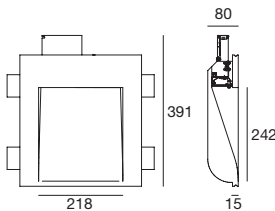

type

White **60940**

source

1xGx24q-3 32W Max

optics

diffused

accessories



60830

Shim



61290

Outer casing



OUTLOOK /



^ OUTLOOK CEILING LIGHTS
< OUTLOOK PENDANT LUMINAIRES

OUTLOOK DOWNLIGHTS



Outlook | Suspended lamp or spotlight for punctual lighting that can also satisfy everyday lighting needs, it creates fascinating lighting effects for interiors.

Materials: white wrinkle-effect coated aluminium casing; transparent glass diffuser.

Outlook_P | Pendant Luminaires | 220-240 V | arrayLED 11 W 250 mA

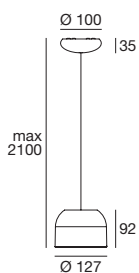

type	colour	optics
White CRI 90 8420	3000 K 1162 lm	diffused

accessories



KIT0026

Phase-cut Dimmer



Outlook_C | Downlights | 220-240 V | arrayLED 11 W 250 mA

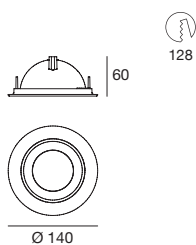

type	colour	optics
White CRI 90 8470	3000 K 1112 lm	diffused

electronics



KIT0064

Phase-cut 1 art.



KIT0065

Phase-cut 2-3 art.



KIT0026

Phase-cut Dimmer



Outlook_S | Ceiling Lights | 220-240 V | arrayLED 11 W 250 mA

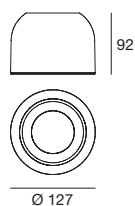
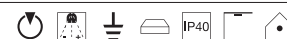

type	colour	optics
White CRI 90 8472	3000 K 1162 lm	diffused

accessories



KIT0026

Phase-cut Dimmer





PELOTA /

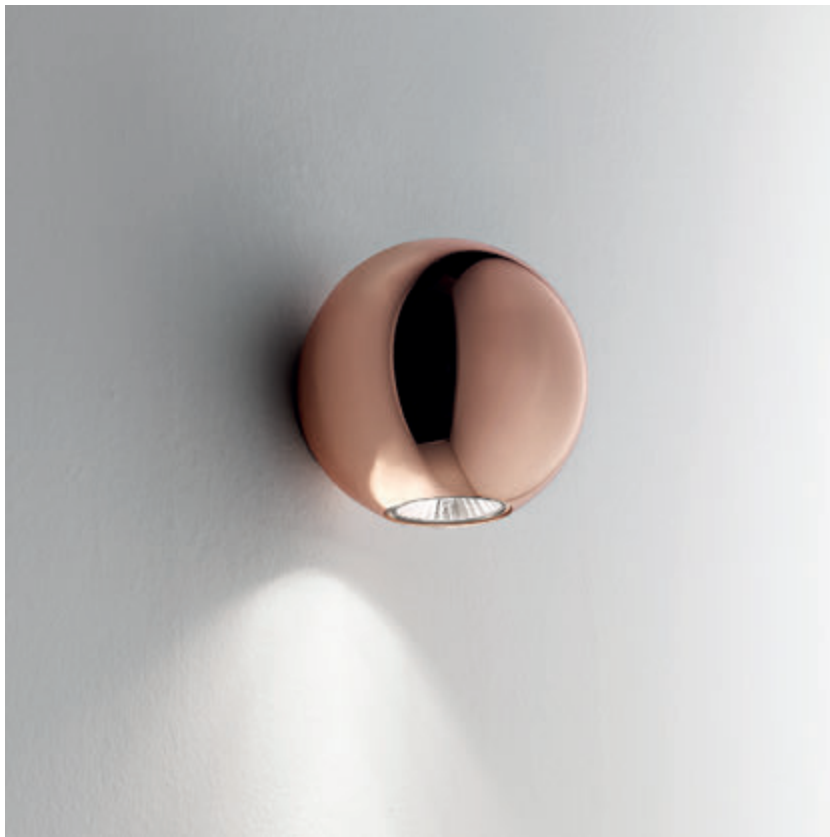

^ PELOTA WALL LIGHTS
< PELOTA PENDANT LUMINAIRES

PELOTA PENDANT LUMINAIRES







PELOTA CEILING LIGHTS

Pelota | A sphere that decorates the wall and presents a shape that's both simple and ancient, with a discreet but intriguing presence.

Materials: matt white coated metal casing with chrome-plated finish or copper effect finish.

Pelota_P | Pendant Luminaires | 220-240 V | 1xGU10

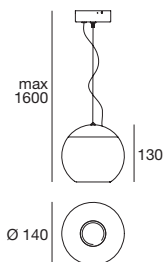
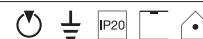

type

White	6835
Chrome	6836
Copper	6837

source

Halogen 1x42 W (included)

optics

diffused

Pelota_S | Ceiling Lights | 220-240 V | 1xGU10

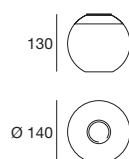
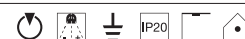

type

White	6617
Chrome	6616
Copper	6618

source

Halogen 1x42 W (included)

optics

diffused

Pelota_W1 | Wall Lights | 220-240 V | 1xGU10

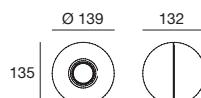

type

White	6614
Chrome	6613
Copper	6615

source

Halogen 1x42 W (included)

optics

diffused

Pelota_W2 | Wall Lights | 220-240 V | 2xGU10

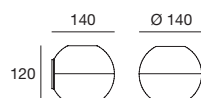
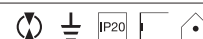

type

White	6611
Chrome	6610
Copper	6612

source

Halogen 2x30 W (included)

optics

diffused



SPOTTY /



^ SPOTTY WALL LIGHTS
^ SPOTTY CEILING LIGHTS
< SPOTTY CEILING LIGHTS

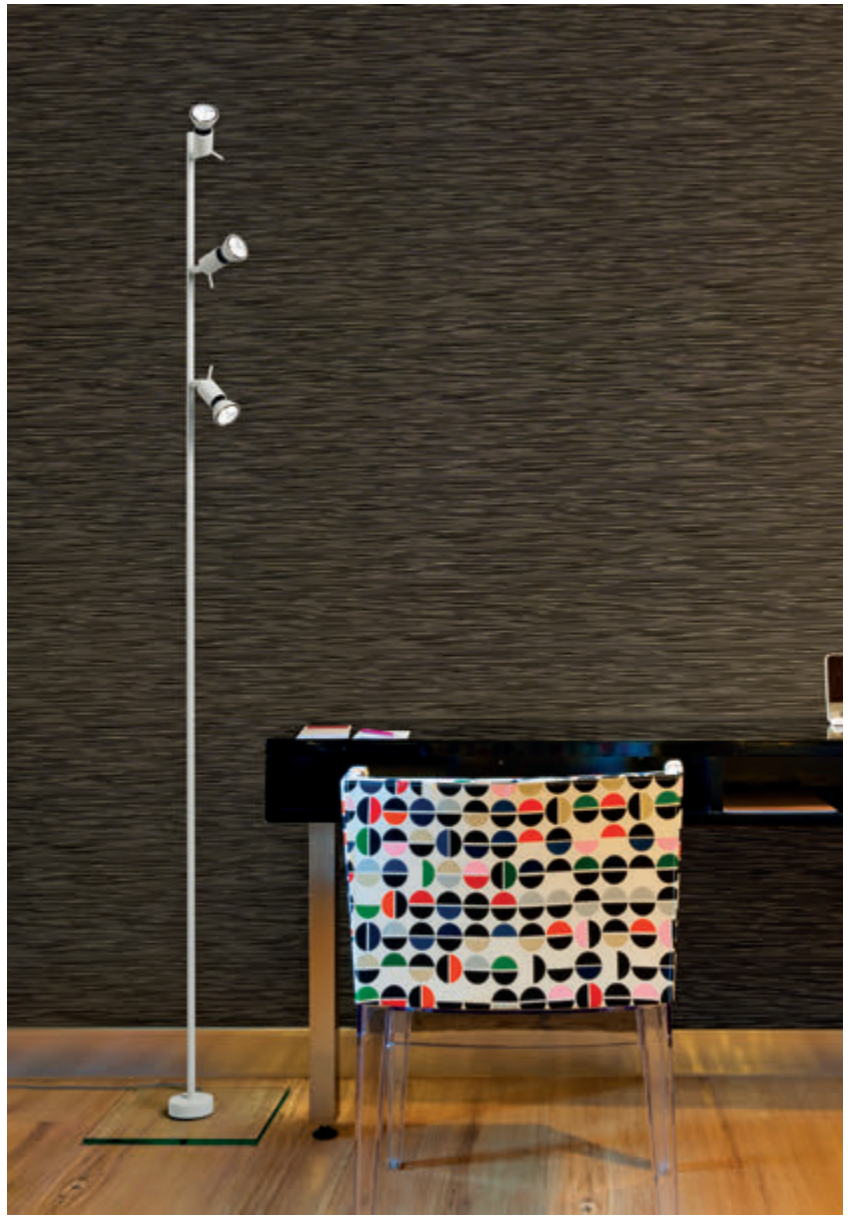

SPOTTY FLOOR LAMPS
SPOTTY TABLE LAMPS



SPOTTY FLOOR LAMPS

Spotty | A directional spotlight, at the service of practicality and maximum flexibility: a punctual light, to emphasize the details of the space, an adjustable light to personalize every environment to the utmost.

Materials: housing in transparent glass and body in metal with chromium finish. Or housing and body in white painted metal.

Spotty_S | Ceiling Lights | 220-240 V | 4xGU10

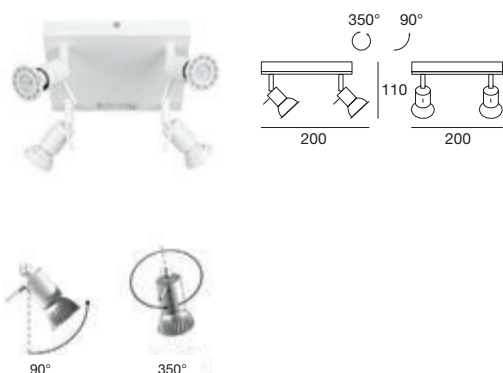
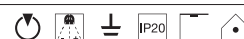

type	source	optics
White 7343	4x42W Max	diffused
Grey 7348		
Chrome 1154		

Spotty_S | Ceiling Lights | 220-240 V | 4xGU10

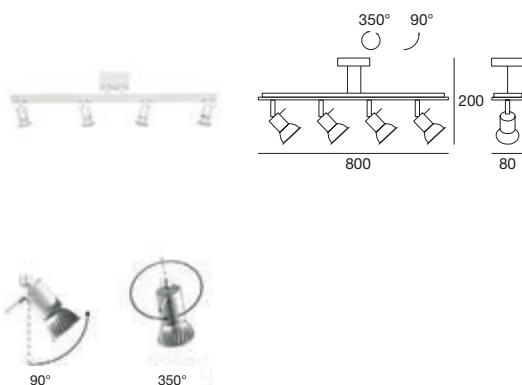

type	source	optics
White 7344	4x42W Max	diffused
Grey 7349		
Chrome 1155		

Spotty_W | Wall Lights | 220-240 V | 1xGU10

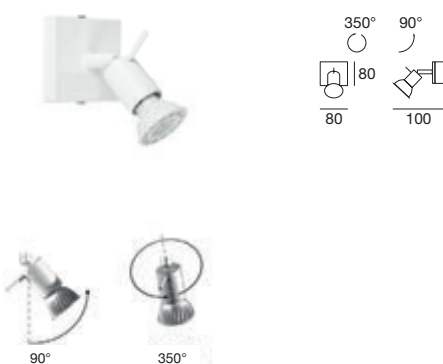
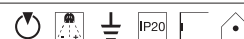

type	source	optics
White 7340	1x42W Max	diffused
Grey 7345		
Chrome 1150		

Spotty_W | Wall Lights | 220-240 V | 2xGU10

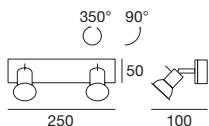

type

White	7341
Grey	7346
Chrome	1152

source

2x42W Max

optics

diffused



Spotty_W | Wall Lights | 220-240 V | 3xGU10

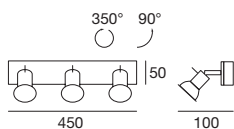
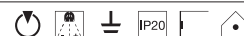

type

White	7342
Grey	7347
Chrome	1153

source

3x42W Max

optics

diffused



Spotty_FL | Floor Lamps | 220-240 V | 3xGU10

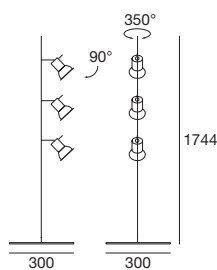

type

Chrome	1158
--------	-------------

source

3x42W Max

optics

diffused



Spotty_FL | Floor Lamps | 220-240 V | 3xGU10

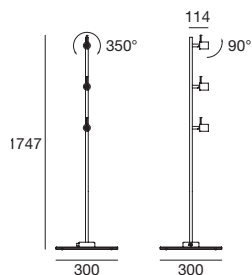

type

White	7350
-------	-------------

source

LED lamp 3x4 W (included)

optics

diffused



Spotty_tab | Table Lamps | 220-240 V | 1xGU10

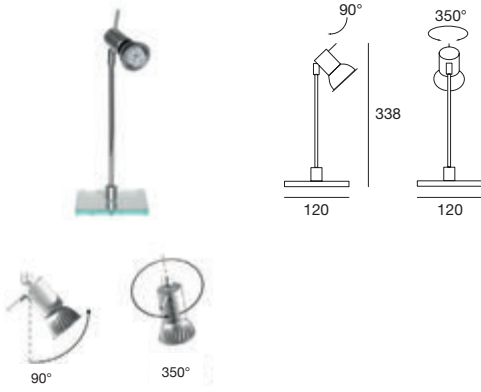

type

Chrome 1157

source

1x42W Max

optics

diffused

Spotty_tab | Table Lamps | 220-240 V | 1xGU10

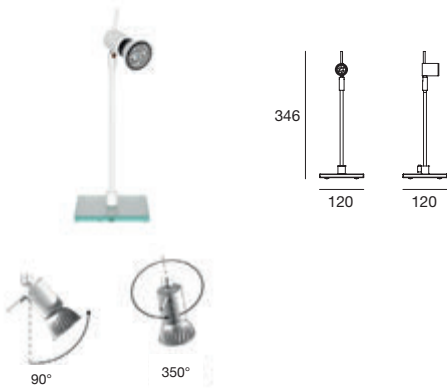

type

White 7352

source

LED lamp 1x4 W (included)

optics

diffused



ORBIS /



^ ORBIS PENDANT LUMINAIRES
< ORBIS WALL LIGHTS



ORBIS PENDANT LUMINAIRES



Orbis | A lamp that does not hide its light source but exalts it, leaving it free to move for maximum customization.

Materials: metal mounting frame with chrome-plated finish; transparent glass diffuser.

Orbis_P | Pendant Luminaires | 220-240 V | 2xGU10

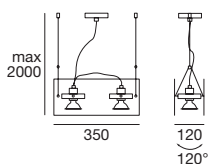
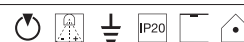

type

Chrome **4610**

source

2x30W Max

optics

diffused

Orbis_P | Pendant Luminaires | 220-240 V | 4xGU10

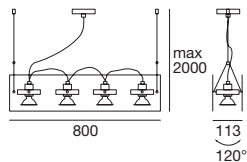
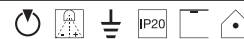

type

Chrome **4604**

source

4x30W Max

optics

diffused

Orbis_S | Ceiling Lights | 220-240 V | 2xGU10

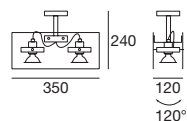
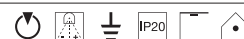

type

Chrome **4609**

source

2x30W Max

optics

diffused

Orbis_S | Ceiling Lights | 220-240 V | 4xGU10

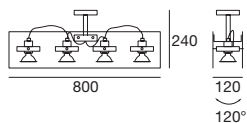

type	source	optics
Chrome 4606	4x30W Max	diffused

Orbis_W | Wall Lights | 220-240 V | 1xGU10

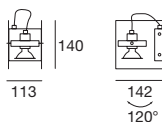
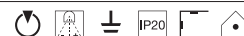

type	source	optics
Chrome 4600	1x30W Max	diffused

Orbis_W | Wall Lights | 220-240 V | 2xGU10

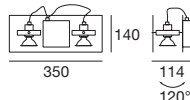
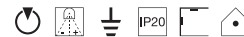

type	source	optics
Chrome 4602	2x30W Max	diffused

Orbis_W | Wall Lights | 220-240 V | 3xGU10

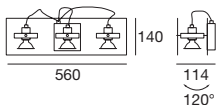

type	source	optics
Chrome 4603	3x30W Max	diffused



new

CRUMB /



CRUMB CEILING LIGHTS



Crumb | Its simplicity is its strength, small cylindrical ceiling lamp. Glass lightness is underlined by lighting softness, two dimensions freely combinable on ceiling or wall.

Materials: white wrinkled coating setting, borosilicate glass diffuser.

Crumb | Ceiling Lights | 220-240 V | topLED 10 W 500 mA

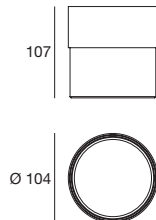

new



type

White CRI 90 **90281**

colour

3000 K 1008 lm

optics

diffused

Crumb | Ceiling Lights | 220-240 V | topLED 15 W 700 mA

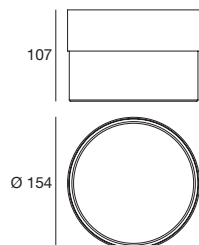

new



type

White CRI 90 **90282**

colour

3000 K 1622 lm

optics

diffused



CAMPANA /



^ CAMPANA CEILING LIGHTS
< CAMPANA PENDANT LUMINAIRES

CAMPANA WALL LIGHTS



Campana | A luminaire that evokes the delicate shape of a white bellflower, stretched out as if looking for the sun.

Materials: casing with chrome-plated or brushed nickel finish; white sandblasted glass diffuser.

Campana_P | Pendant Luminaires | 220-240 V | 1xE14

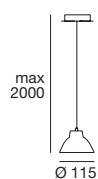
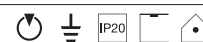

type

Nickel **4430**

source

1x46W Max

optics

diffused

Campana_P | Pendant Luminaires | 220-240 V | 1xE27

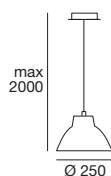

type

Nickel **4431**

source

1x57W Max

optics

diffused

Campana_P | Pendant Luminaires | 220-240 V | 2xE27

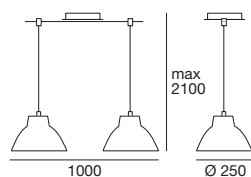
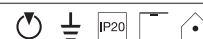

type

Nickel **4432**

source

2x57W Max

optics

diffused

Campana_P | Pendant Luminaires | 220-240 V | 1xE27

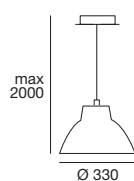

type

Nickel **4433**

source

1x77W Max

optics

diffused

Campana_S | Ceiling Lights | 220-240 V | 3xE14

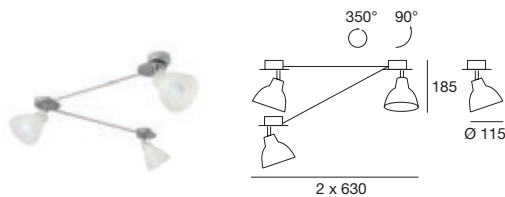

type	source	optics
Nickel 4428	3x30W Max	diffused

Campana_S | Ceiling Lights | 220-240 V | 5xE14

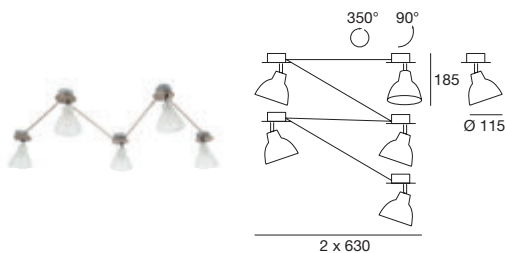
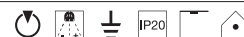

type	source	optics
Nickel 4429	5x30W Max	diffused

Campana_W | Wall Lights | 220-240 V | 1xE14

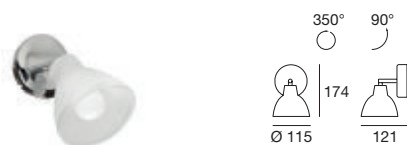
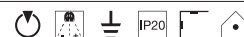

type	source	optics
Chrome 4405	1x30W Max	diffused
Nickel 4425		

Campana_W | Wall Lights | 220-240 V | 2xE14

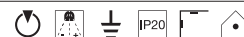

type	source	optics
Chrome 4402	2x30W Max	diffused
Nickel 4422		

Campana_W | Wall Lights | 220-240 V | 3xE14

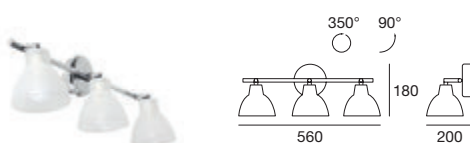
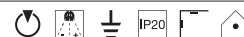

type	source	optics
Chrome 4403	3x30W Max	diffused
Nickel 4423		



THANK YOU /



^ THANK YOU CEILING LIGHTS
< THANK YOU WALL LIGHTS

THANK YOU PENDANT LUMINARES







THANK YOU TABLE LAMPS



THANK YOU FLOOR LAMPS



THANK YOU WALL LIGHTS

THANK YOU WALL LIGHTS







^ THANK YOU NAKED CEILING LIGHTS
^ THANK YOU NAKED TABLE LAMPS
< THANK YOU NAKED PENDANT LUMINAIRES

Thank You | A complete range of products, celebration of the ingenious light bulb invented by Thomas Edison in 1879, which began the era of electric light.

Materials: white or brown wrinkled coating metal setting; lampshade with wood or fabric finishes.

Thank You_P | Pendant Luminaires | 220-240 V | 1xE27

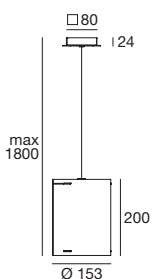

new



type

White	Ash Wood	8057
White	Mesh	8058
Brown	Ash Wood	8059
Brown	Mesh	8060

source

1x57 W Max

optics

diffused

Thank You_P | Pendant Luminaires | 220-240 V | 1xE27

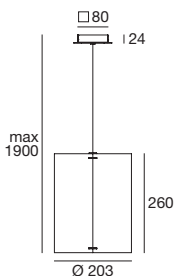

new



type

White	Ash Wood	8061
White	Mesh	8062
Brown	Ash Wood	8063
Brown	Mesh	8064

source

1x57 W Max

optics

diffused

Thank You_P | Pendant Luminaires | 220-240 V | 1xE27

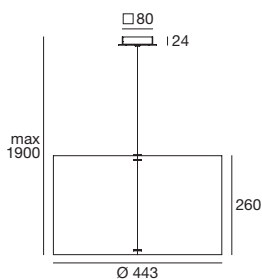

new



type

White	Ash Wood	8065
White	Mesh	8066
Brown	Ash Wood	8067
Brown	Mesh	8068

source

1x57 W Max

optics

diffused

Thank You_S | Ceiling Light | 220-240 V | 1xE27

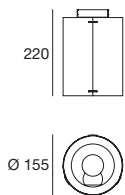

new



type		
White	Ash Wood	8049
White	Mesh	8050
Brown	Ash Wood	8051
Brown	Mesh	8052

source
1x57 W Max

optics
diffused

Thank You_W1 | Wall Lights | 220-240 V | 1xE27

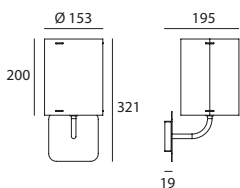

new

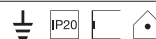

type		
White	Ash Wood	8053
White	Mesh	8054
Brown	Ash Wood	8055
Brown	Mesh	8056

source
1x57 W Max

optics
diffused

Thank You_W2 | Wall Lights | 220-240 V | 1xE27

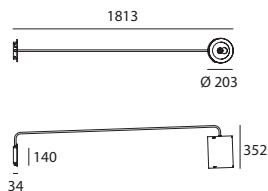

new



type		
White	Ash Wood	8073
White	Mesh	8074
Brown	Ash Wood	8075
Brown	Mesh	8076

source
1x57 W Max

optics
diffused

Thank You_W3 | Wall Lights | 220-240 V | 1xE27

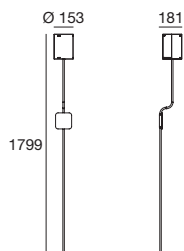

new



type		
White	Ash Wood	8069
White	Mesh	8070
Brown	Ash Wood	8071
Brown	Mesh	8072

source
1x57 W Max

optics
diffused

Thank You_FL | Floor Lamps | 220-240 V | 1xE27



new

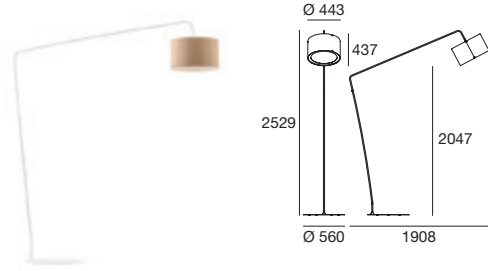

type

White	Ash Wood	8077
White	Mesh	8078
Brown	Ash Wood	8079
Brown	Mesh	8080

source

1x57 W Max

optics

diffused

Thank You_tab | Table Lamps | 220-240 V | 1xE27



new

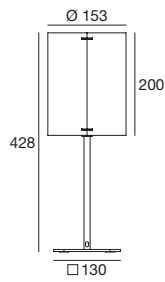

type

White	Ash Wood	8045
White	Mesh	8046
Brown	Ash Wood	8047
Brown	Mesh	8048

source

1x57 W Max

optics

diffused

Thank You_P naked | Pendant Luminaires | 220-240 V | 1xE27

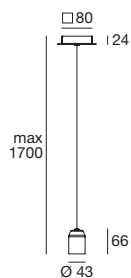

new



type

White **8221**Brown **8222**

source

1x57 W Max

optics

diffused

Thank You_S naked | Ceiling Light | 220-240 V | 1xE27

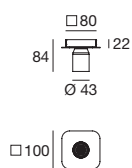

new

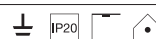

type

White **8217**Brown **8218**

source

1x57 W Max

optics

diffused

Thank You_W1 naked | Wall Light | 220-240 V | 1xE27

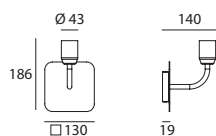

new

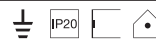

type

White **8219**Brown **8220**

source

1x57 W Max

optics

diffused

Thank You_W2 naked | Wall Light | 220-240 V | 1xE27

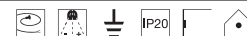

type

White **7727**Brown **7728**

source

1x57 W Max

optics

diffused

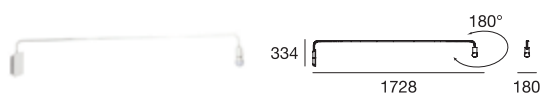

Thank You_W3 naked | Wall Light | 220-240 V | 1xE27

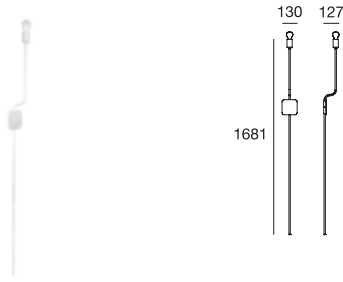

type

White	7725
Brown	7726

source

1x57 W Max

optics

diffused

Thank You_FL naked | Floor Lamps | 220-240 V | 1xE27

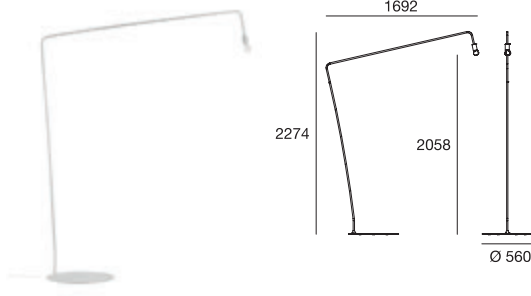

type

White	7733
Brown	7734

source

1x57 W Max

optics

diffused

Thank You_tab naked | Table Lamps | 220-240 V | 1xE27

new

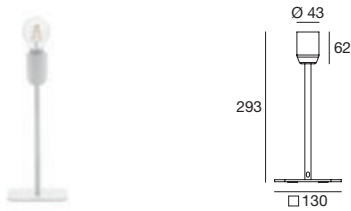

type

White	8215
Brown	8216

source

1x57 W Max

optics

diffused



new

Home Lighting 1.0_indoor

SISTERS /





SISTERS PENDANT LUMINAIRES

Sisters | Ancient memories shapes, in blown glass. Suspensions embellished by the roundel rich finishes. Precious suspension lamp, for elegant and refined spaces.

Materials: natural polythene diffuser, roundel in chrome, gold or copper ABS finish.

Sisters_1 | Pendant Luminaires | 220-240 V | 1xE27

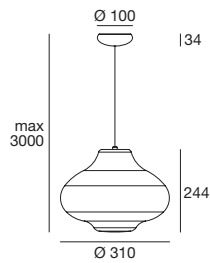

new



type

White	Dark Ch.	8387
White	Gold	8388
White	Copper	8389

source

1x46 W Max

optics

diffused

Sisters_2 | Pendant Luminaires | 220-240 V | 1xE27

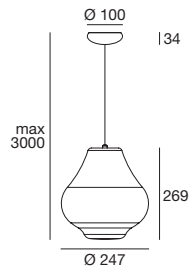

new

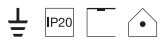

type

White	Dark Ch.	8384
White	Gold	8385
White	Copper	8386

source

1x46 W Max

optics

diffused



VULCANO_IN /



^ VULCANO CEILING LIGHTS
< VULCANO PENDANT LUMINAIRES



VULCANO PENDANT LUMINAIRES

Vulcano | A small volcano, whether in suspension or attached to the ceiling, attracts attention by releasing a light that envelops the room.

Materials: white linear polyethylene casing for diffused lighting; matt white coated metal mounting frame.

Vulcano_P | Pendant Luminaires | 220-240 V | topLED 23 W 500 mA

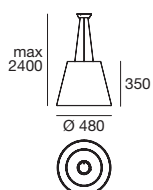
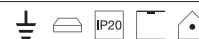

type

White CRI 90 **10330**

colour

3000 K 2794 lm

optics

diffused

Vulcano_P | Pendant Luminaires | 220-240 V | topLED 32 W 700 mA

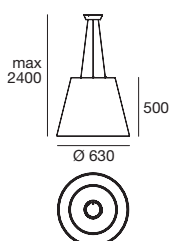

type

White CRI 90 **10335**

colour

3000 K 3929 lm

optics

diffused

Vulcano_S | Ceiling Lights | 220-240 V | topLED 23 W 500 mA

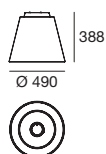

type

White CRI 90 **10331**

colour

3000 K 2794 lm

optics

diffused

Vulcano_S | Ceiling Lights | 220-240 V | topLED 32 W 700 mA

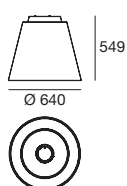

type

White CRI 90 **10336**

colour

3000 K 3929 lm

optics

diffused



ZIG ZAG /



^ ZIG ZAG PENDANT LUMINAIRES
< ZIG ZAG WALL LIGHTS

Zig Zag | An apparent inclination that entertains with its geometry: a lamp with clean and elegant lines.

Materials: glossy white coated metal mounting frame; casing made of white wrinkle-effect coated metal or of anodised aluminium; white sandblasted glass diffuser.

Zig Zag_P | Pendant Luminaires | 220-240 V | 2xE27

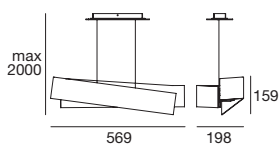
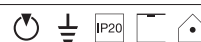

type

White	6991
Black	6995
Anod. Al.	6994

source

2x57 W Max

optics

diffused

Zig Zag_S | Ceiling Lights | 220-240 V | 2xE27

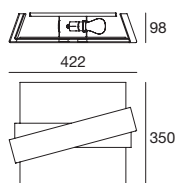

type

White	7400
Black	7402
Anod. Al.	7401

source

2x46 W Max

optics

diffused

Zig Zag_S | Ceiling Lights | 220-240 V | 4xE27

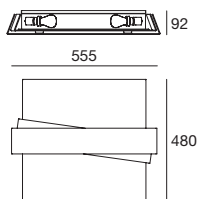

type

White	7290
Black	7289
Anod. Al.	7291

source

4x46 W Max

optics

diffused

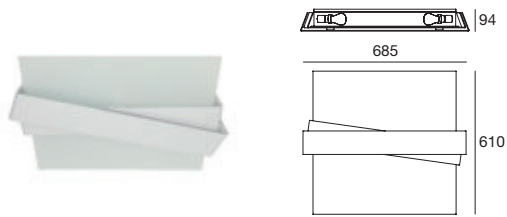
Zig Zag_S | Ceiling Lights | 220-240 V | 4xE27**type**White **7292**Black **7294**Anod. Al. **7293****source**

4x46 W Max

optics

diffused

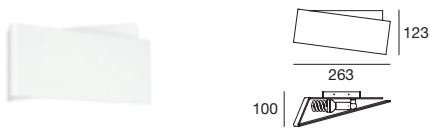
Zig Zag_W | Wall Lights | 220-240 V | 1xG9**type**White **6986**Black **6989**Anod. Al. **7001****source**

Halogen 1x48 W (included)

optics

diffused

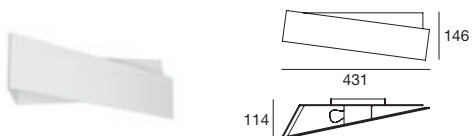
Zig Zag_W | Wall Lights | 220-240 V | 1xE27**type**White **6986**Black **6989**Anod. Al. **6990****source**

1x57 W Max

optics

diffused

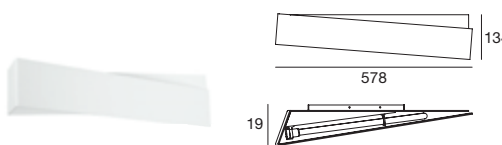
Zig Zag_W | Wall Lights | 220-240 V | 1x2G11**type**White **7002**Black **7005**Anod. Al. **7006****source**

Fluorescent 1x36 W (included)

optics

diffused



FACE /



- ^ FACE CEILING LIGHTS
- ^ FACE WALL LIGHTS
- < FACE PENDANT LUMINAIRES

Face | The light of this pendant light spreads imaginatively from the many facets of the casing, sometimes more intensely, sometimes softer.

Materials: metal mounting frame with white wrinkle-effect finish; white silk-screened and white sandblasted glass diffuser.

Face_P | Pendant Luminaires | 220-240 V | 4xE27

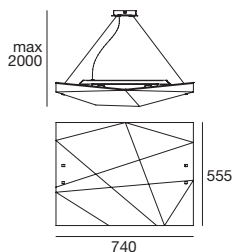

type

White **7475**

source

4x46 W Max

optics

diffused

Face_S | Ceiling Lights | 220-240 V | 2xE27

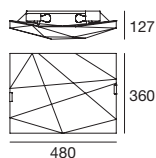

type

White **7476**

source

2x57 W Max

optics

diffused

Face_S | Ceiling Lights | 220-240 V | 4xE27

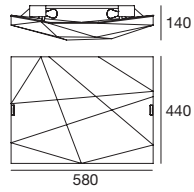

type

 7477

source

4x46 W Max

optics

diffused

Face_S | Ceiling Lights | 220-240 V | 4xE27

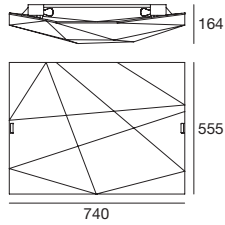

type

 7478

source

4x46 W Max

optics

diffused

Face_W | Wall Lights | 220-240 V | 2xE27

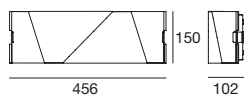

type

 7479

source

2x46 W Max

optics

diffused



new

CREW /

Home Lighting 1.0_indoor



CREW CEILING LIGHTS



CREW CEILING LIGHTS

Crew | Ceiling lamps wrapping frames, simple and lively shapes. Defined by modern and refined finishes, decorates living space with simplicity. Delicate lighting presence.

Materials: coated metal setting: version S1 wrinkled white, brown brushed iron; version S2 bicolor black/white, black/gold, white/copper or sablé/green; version S3 wrinkled white, copper or brushed aluminum. Polymethylmethacrylate diffuser.

Crew_1 | Ceiling Lights | 220-240 V | topLED 12 W 300 mA

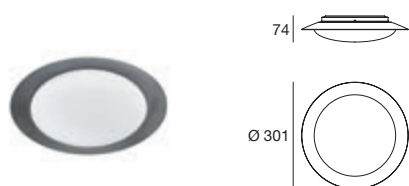

new



type

White	CRI 80	8270
Dark Grey	CRI 80	8271
Burned	CRI 80	8272

colour

3000 K 1350 lm

optics

diffused

Crew_1 | Ceiling Lights | 220-240 V | topLED 17 W 400 mA

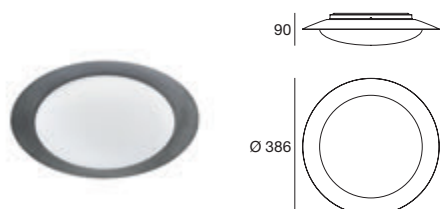

new



type

White	CRI 80	8275
Dark Grey	CRI 80	8276
Burned	CRI 80	8277

colour

3000 K 1800 lm

optics

diffused

Crew_1 | Ceiling Lights | 220-240 V | topLED 22 W 400 mA

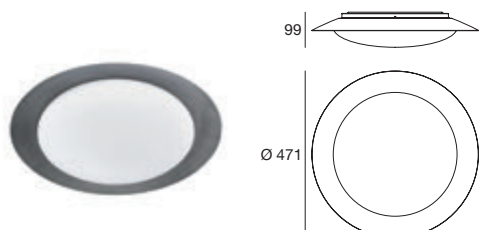

new



type

White	CRI 80	8280
Dark Grey	CRI 80	8281
Burned	CRI 80	8282

colour

3000 K 2700 lm

optics

diffused

Crew_2 | Ceiling Lights | 220-240 V | topLED 12 W 300 mA



new



type		colour	optics
White	CRI 80	3000 K 1350 lm	diffused
White	Copper		
Black	White		
Black	Gold		
Sablè	Green		
	CRI 80		
	CRI 80		
	CRI 80		
	CRI 80		

Crew_2 | Ceiling Lights | 220-240 V | topLED 17 W 400 mA

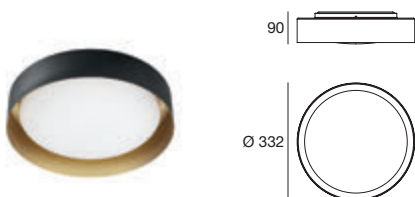

new



type		colour	optics
White	CRI 80	3000 K 1800 lm	diffused
White	Copper		
Black	White		
Black	Gold		
Sablè	Green		
	CRI 80		
	CRI 80		
	CRI 80		
	CRI 80		

Crew_2 | Ceiling Lights | 220-240 V | topLED 22 W 400 mA



new



type		colour	optics
White	CRI 80	3000 K 2700 lm	diffused
White	Copper		
Black	White		
Black	Gold		
Sablè	Green		
	CRI 80		
	CRI 80		
	CRI 80		
	CRI 80		

Crew_3 | Ceiling Lights | 220-240 V | topLED 12 W 300 mA

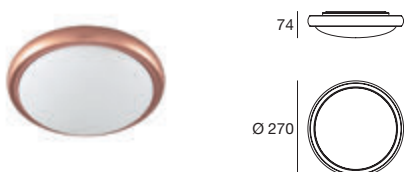

new



type		colour	optics
White	CRI 80	3000 K 1350 lm	diffused
Brush.Gr.	CRI 80		
Copper	CRI 80		

Crew_3 | Ceiling Lights | 220-240 V | topLED 17 W 400 mA

new

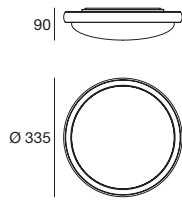

type

White	CRI 80	8311
Brush.Gr.	CRI 80	8312
Copper	CRI 80	8313

colour

3000 K 1800 lm

optics

diffused

Crew_3 | Ceiling Lights | 220-240 V | topLED 22 W 400 mA

new

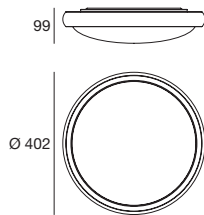

type

White	CRI 80	8316
Brush.Gr.	CRI 80	8317
Copper	CRI 80	8318

colour

3000 K 2700 lm

optics

diffused

Crew_1 | Finishes



Crew_2 | Finishes



Crew_3 | Finishes





TARA /



TARA CEILING LIGHTS

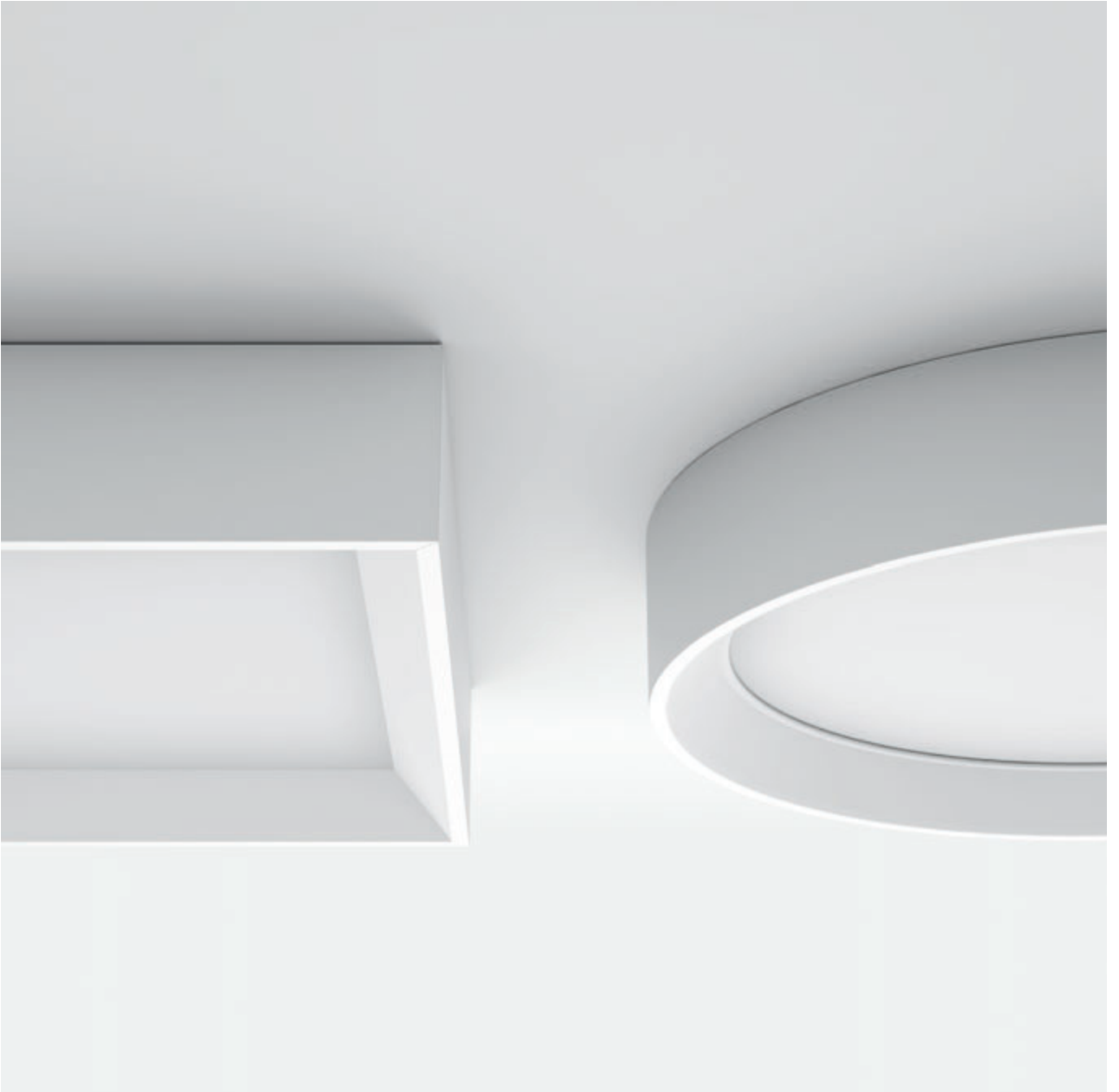

TARA CEILING LIGHTS

Tara | A reliable, round or squared, ceiling lamp. The inward edge softens minimal and severe lines, esthetically enhancing the lamp with the utmost details attention.

Materials: white wrinkled coating aluminum setting, polymethylmethacrylate diffuser.

Tara_Q | Ceiling Lights | 220-240 V | topLED 23 W 500 mA



new



type

colour

optics

White CRI 80 **8325**

3000 K 3050 lm

diffused

Tara_Q | Ceiling Lights | 220-240 V | topLED 33 W 700 mA

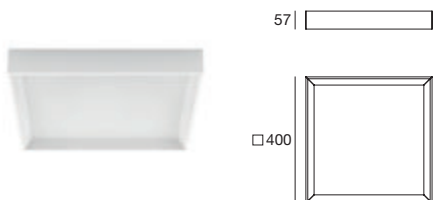

new



type

colour

optics

White CRI 80 **8328**

3000 K 4290 lm

diffused

Tara_Q | Ceiling Lights | 220-240 V | topLED 45 W 1050 mA

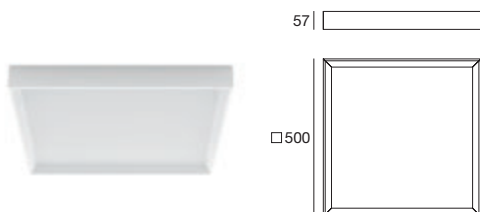

new



type

colour

optics

White CRI 80 **8331**

3000 K 6100 lm

diffused

Tara_R | Ceiling Lights | 220-240 V | topLED 23 W 1050 mA

new



55 |

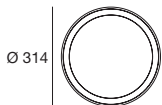

type

White CRI 80 **8334**

colour

3000 K 3050 lm

optics

diffused

Tara_R | Ceiling Lights | 220-240 V | topLED 33 W 700 mA

new



55 |

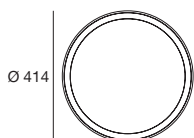

type

White CRI 80 **8337**

colour

3000 K 4290 lm

optics

diffused

Tara_R | Ceiling Lights | 220-240 V | topLED 45 W 1050 mA

new



55 |

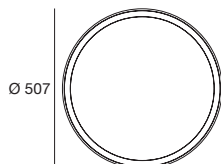

type

White CRI 80 **8340**

colour

3000 K 6100 lm

optics

diffused



new

SPARK /



SPARK CEILING LIGHTS

SPARK CEILING LIGHTS



Spark | Micro perforated glass diffuser ceiling lamp, such a precious transparent and luminous constellation. A little sky in the room

Materials: white or black wrinkled coating setting, or chrome, serigraph glass diffuser.

Spark | Ceiling Lights | 220-240 V | topLED 12 W 300 mA

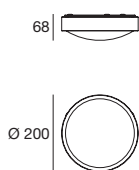

new



type

colour

optics

White CRI 90 **90290**

3000 K 884 lm

diffused

Chrome CRI 90 **90291**

Spark | Ceiling Lights | 220-240 V | topLED 18 W 300 mA

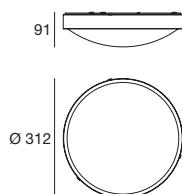

new



type

colour

optics

White CRI 90 **90292**

3000 K 1617 lm

diffused

Chrome CRI 90 **90293**

Spark | Ceiling Lights | 220-240 V | topLED 30 W 400 mA

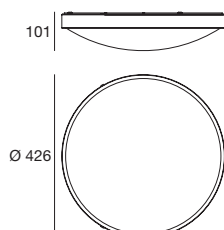

new



type

colour

optics

White CRI 90 **90294**

3000 K 2447 lm

diffused

Chrome CRI 90 **90295**



new

JOSHUA /

Home Lighting 1.0_indoor



JOSHUA FLOOR LAMPS



Joshua | Round diffuser indirect and dynamic lighting floor lamp, the tilting movement allows luminous shades and effects, always different.

Materials: steel setting and aluminum structure, white or black wrinkled coating. Polymethylmethacrylate diffuser.

Joshua | Floor Lamps | 220-240 V | topLED 25 W 700 mA

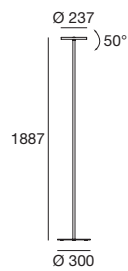

new



type

White	CRI 80	8365
Black	CRI 80	8366

colour

3000 K 2500 lm

optics

diffused



new

Home Lighting 1.0_indoor

ZEBRA /



^ ZEBRA WALL LIGHTS
< ZEBRA CEILING LIGHTS

Zebra | Ceiling or wall lamp defined by a rich geometric decoration. Double emission creates a suggestive lighting corona, a delicate halo emphasizing the original striped pattern.

Materials: steel white wrinkled coating setting, polymethylmethacrylate diffuser.

Zebra_W | Wall Lights | 220-240 V | topLED 15 W 350 mA

new



type	colour	optics
White CRI 80 8245	3000 K 1695 lm	diffused



Zebra_W | Wall Lights | 220-240 V | topLED 29 W 700 mA

new



type	colour	optics
White CRI 80 8246	3000 K 3390 lm	diffused

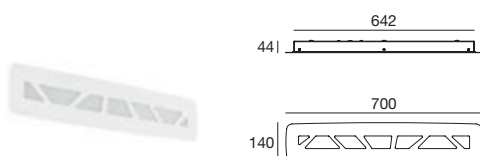

Zebra_S | Ceiling Lights | 220-240 V | topLED 26 W 700 mA

new



type	colour	optics
White CRI 80 8247	3000 K 2726 lm	diffused



Zebra_S | Ceiling Lights | 220-240 V | topLED 35 W 920 mA

new



type

White CRI 80 **8248**

colour

3000 K 3913 lm

optics

diffused

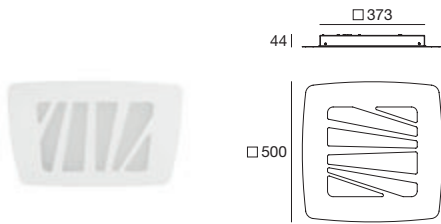

Zebra_S | Ceiling Lights | 220-240 V | topLED 46 W 1050 mA

new



type

White CRI 80 **8249**

colour

3000 K 4907 lm

optics

diffused

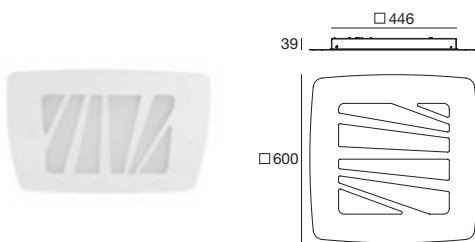



POE /



^ POE FLOOR LAMPS
< POE PENDANT LUMINAIRES

POE PENDANT LUMINAIRES
> POE FLOOR LAMPS







Poe | Indirect lighting extra thin vertical stem.
Light is only where needed, punctual and precise. Its essentiality is perfect in every living space.

Materials: white or black wrinkled coating setting, or copper finish.
Polymethylmethacrylate diffuser.

Poe_P | Pendant Luminaires | 220-240 V | topLED 7 W 700 mA

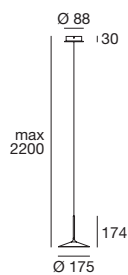

new



type

White	CRI 80	8350
Black	CRI 80	8351
Copper	CRI 80	8352

colour

3000 K 785 lm

optics

diffused

Poe_FL | Floor Lamps | 220-240 V | topLED 25 W 700 mA

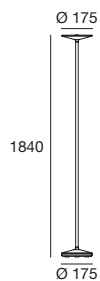

new



type

White	CRI 80	8345
Black	CRI 80	8346
Copper	CRI 80	8347

colour

3000 K 2500 lm

optics

diffused



BABY MARGE /



BABY MARGE TABLE LAMPS



Baby Marge | Whimsical, fun, safe: a table luminaire with no cable that cheers up everywhere it is turned on.

Materials: white linear polyethylene.

Baby Marge | Table Lamps | 220-240 V | 1 x powerLED 0,5 W 230 V



type	colour	optics
White 15000	RGB	diffused





new

METAL /

Home Lighting 1.0_indoor





^ METAL WALL LIGHTS
< METAL CEILING LIGHTS



Metal | The balance between strong and delicate elements creates a ceiling light or wall light with indirect emission that expresses a pure and straightforward beauty.

Materials: white wrinkled coating aluminum mounting frame; white silk-screened and sandblasted glass diffuser (ceiling light version).

Metal_W | Wall Lights | 220-240 V | topLED 11 W 500 mA

new     



type		colour	optics
White	CRI 90 90320	3000 K 1211 lm	diffused
Polish Al.	CRI 90 90321		

Metal_W | Wall Lights | 220-240 V | topLED 20 W 900 mA

new     



type		colour	optics
White	CRI 90 90322	3000 K 2135 lm	diffused
Polish Al.	CRI 90 90323		

Metal_W | Wall Lights | 220-240 V | topLED 30 W 1400 mA

new     



type		colour	optics
White	CRI 90 90324	3000 K 3306 lm	diffused
Polish Al.	CRI 90 90325		

Metal_S | Ceiling Lights | 220-240 V | topLED 11 W 500 mA

new

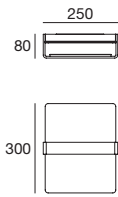

type

White	CRI 90	90326
Polish Al.	CRI 90	90327

colour

3000 K 1211 lm

optics

diffused

Metal_S | Ceiling Lights | 220-240 V | topLED 20 W 900 mA

new

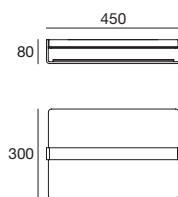

type

White	CRI 90	90328
Polish Al.	CRI 90	90329

colour

3000 K 2135 lm

optics

diffused

Metal_S | Ceiling Lights | 220-240 | topLED 30 W 1400 mA

new

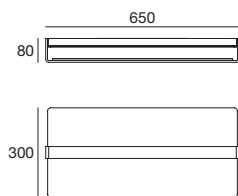
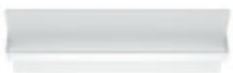

type

White	CRI 90	90330
Polish Al.	CRI 90	90331

colour

3000 K 3306 lm

optics

diffused



MOLEDRO /



^ MOLEDRO CEILING LIGHTS
< MOLEDRO PENDANT LUMINAIRES

MOLEDRO WALL LIGHTS



Moledro | A luminaire like a small statue, like stones left in order to recall a passage in remote lands, marks the way towards new, bright travels.

Materials: body in textured painted metal; diffuser in white sanded glass or with gold sheet finish in the wall mounted version.

Moledro_P | Pendant Luminaires | 220-240 V | 3xE27

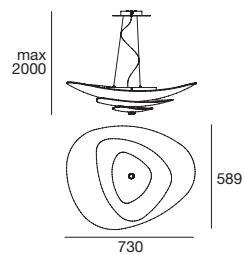

type

White **90239**

source

3x46 W Max

optics

diffused

Moledro_P | Pendant Luminaires | 220-240 V | 3xE27

new

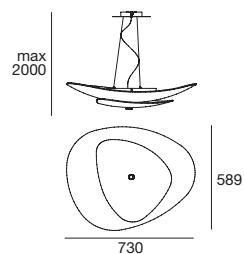

type

White **Gold** **90318**

source

3x46 W Max

optics

diffused

Moledro_S | Ceiling Lights | 220-240 V | 3xE27

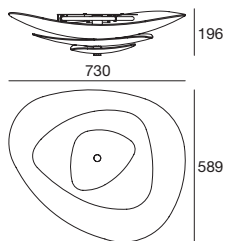
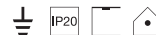

type

White **90238**

source

3x46 W Max

optics

diffused

Moledro_S | Ceiling Lights | 220-240 V | 3xE27

new

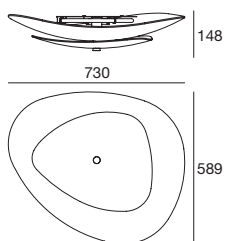
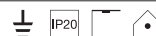

type

White **Gold** **90317**

source

3x46 W Max

optics

diffused

Moledro | Wall Lights | 220-240 V | 2xE27

new

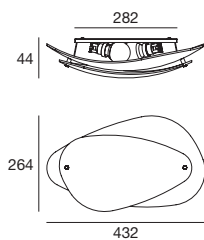
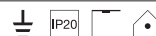

type

White **90315**

White **Gold** **90316**

source

2x46 W Max

optics

diffused



MADERA /



^ MADERA CEILING LIGHTS
< PMADERA WALL LIGHTS

Madera | A decorative luminaire appealing to lovers of classical and modern lines alike. The beautiful, essential design is guaranteed to add that very special element of style that only wood can infuse in an environment.

Materials: frame in natural or grey oak; diffuser made of transparent glass with black silk-screened edge, silk-screened/sandblasted or sandblasted glass.

Madera_S1 | Ceiling Lights | 220-240 V | 1xGU10



type

Oak W. **90265**
 Grey,O.W. **90266**

source

1x30 W Max

optics

diffused

Madera_S2 | Ceiling Lights | 220-240 V | 2xE27

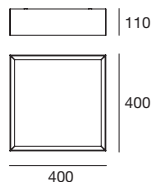

type

Oak W. **90269**
 Grey,O.W. **90270**

source

2x46 W Max

optics

diffused

Madera_S2 | Ceiling Lights | 220-240 V | 4xE27

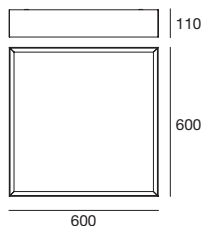

type

Oak W. **90271**
 Grey,O.W. **90272**

source

4x46 W Max

optics

diffused

Madera_W | Wall Lights | 220-240 V | 1xG9

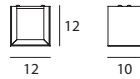
**type**Oak W. **90267**Grey.O.W. **90268****source**

1x20 W Max

optics

diffused

Madera_W | Wall Lights | 220-240 V | 1xE27

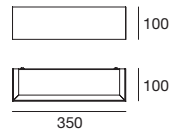
**type**Oak W. **90273**Grey.O.W. **90274****source**

Halogen 1x30 W Max

optics

diffused

Madera_W | Wall Lights | 2xE27

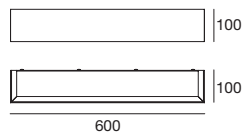
**type**Oak W. **90275**Grey.O.W. **90276****source**

Halogen 2x30 W Max

optics

diffused



SOLIDO /



SOLIDO WALL LIGHTS



SOLIDO CEILING LIGHTS

Solido | A minimalist buckle seems to support a light ribbon allowing it to pass delicately through and then blocking it to emit a soft light from the ceiling or wall.

Materials: casing in metal with chrome finish or white painted wood or oak wood; silk-screened/sandblasted glass diffuser.

Solido_S | Ceiling Lights | 220-240 V | 2xE27

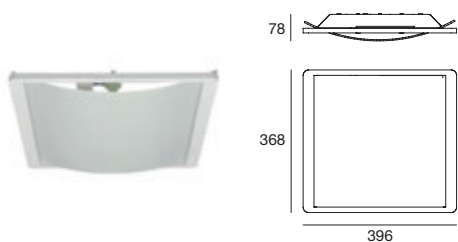
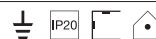

type	source	optics
White 90259	2x46 W Max	diffused
Oak W. 90260		
Chrome 90263		

Solido_W | Wall Lights | 220-240 V | 1xE14

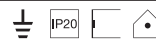

type	source	optics
White 90255	1x46 W Max	diffused
Oak W. 90256		
Chrome 90261		

Solido_W | Wall Lights | 220-240 V | 2xE14



type	source	optics
White 90257	2x46 W Max	diffused
Oak W. 90258		
Chrome 90262		



SIPARIO_NOVE99 /



^ NOVE99 WALL LIGHTS
< SIPARIO CEILING LIGHTS

Sipario | A soft cloth is lifted suddenly as if to reveal the surrounding environment, to then stop mid-fall, as if hung from the ceiling, softly illuminating the space.

Materials: glossy white coated metal mounting frame; white silk-screened glass diffuser.

Nove99 | A transparency that by thickening, turns into a light that expands into space, from the wall and from the ceiling.

Materials: matt white coated metal mounting frame; casing made of metal with decorative elements with brushed nickel finish, or of cherry wood; diffuser made of transparent and white silk-screened glass.

Sipario | Ceiling Lights | 220-240 V | 2xE27

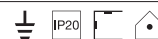

type

White **73398**

source

2x46 W Max

optics

diffused

Sipario | Ceiling Lights | 220-240 V | 3xE27

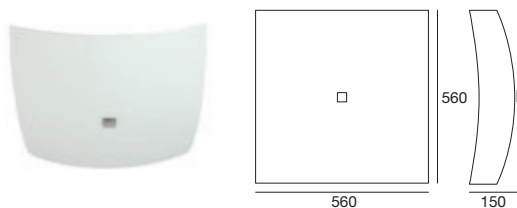
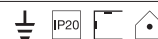

type

White **73399**

source

3x30W Max

optics

diffused

Nove99_S | Ceiling Lights | 220-240 V | 2xE27

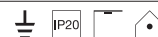

type

White **Nickel** **78200**
White **Oak W.** **78226**

source

2x30 W Max

optics

diffused

Nove99_S | Ceiling Lights | 220-240 V | 3xE27

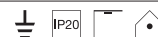

type

White **Nickel** **78202**
White **Oak W.** **78228**

source

3x30 W Max

optics

diffused

Nove99_W1 | Wall Lights | 220-240 V | 1xE14

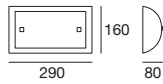
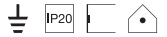
**type**

White	Nickel	78220
White	Oak W.	78221

source

1x30 W Max

optics

diffused

Nove99_W1 | Wall Lights | 220-240 V | 2xE14

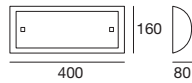
**type**

White	Nickel	78222
White	Oak W.	78223

source

2x30 W Max

optics

diffused

Nove99_W1 | Wall Lights | 220-240 V | 4xE14

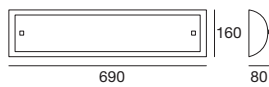
**type**

White	Nickel	78224
White	Oak W.	78225

source

4x30 W Max

optics

diffused

Nove99_W2 | Wall Lights | 220-240 V | 1xE14

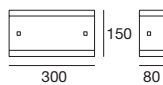
**type**

White	Nickel	71204
White	Oak W.	71230

source

1x46 W Max

optics

diffused



HULA HOOP /

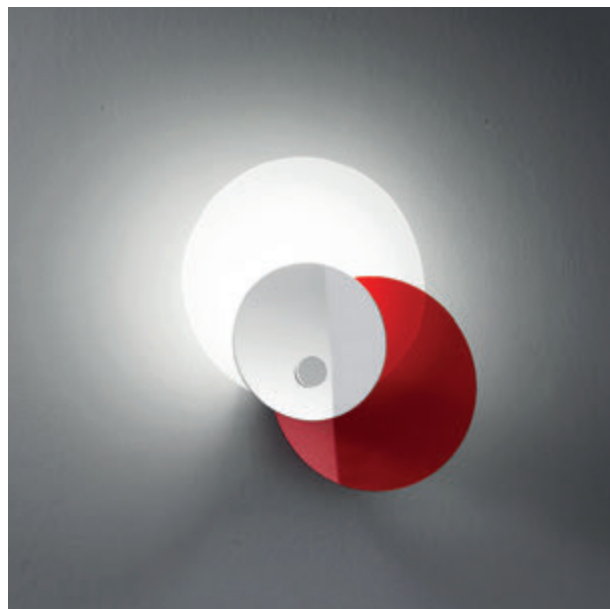

HULA HOOP WALL LIGHTS

Hula Hoop | The movement of planets that appear superimposed, like an ellipse that withdraws or gives light to every step, for a luminaire that loves to play with the colours and perspective, on both the ceiling and the wall.

Materials: glossy white coated metal mounting frame; diffuser consisting of a white silk-screened and sandblasted glass element and two/three elements made of blue, yellow, red, orange and chrome polymethylmethacrylate.

Hula Hoop_S | Ceiling Lights | 220-240 V | 2xE27

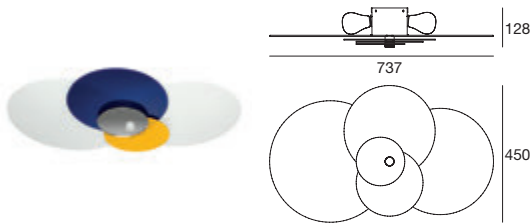

type	source	optics
<input type="checkbox"/> White <input checked="" type="checkbox"/> 90212 <input checked="" type="checkbox"/> Blue <input type="checkbox"/> Chrome <input checked="" type="checkbox"/> Yellow	2x57 W Max	diffused

Hula Hoop_S | Ceiling Lights | 220-240 V | 2xE27

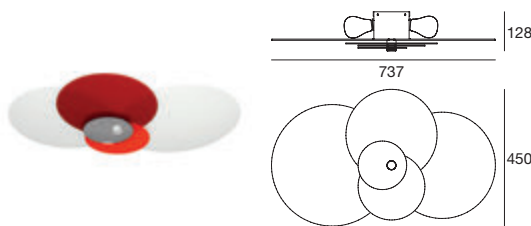
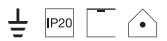

type	source	optics
<input type="checkbox"/> White <input checked="" type="checkbox"/> 90235 <input type="checkbox"/> Chrome <input checked="" type="checkbox"/> Red <input checked="" type="checkbox"/> Orange	2x57 W Max	diffused

Hula Hoop_W | Wall Lights | 220-240 V | 1xE27



type	source	optics
<input type="checkbox"/> White <input checked="" type="checkbox"/> 90213 <input checked="" type="checkbox"/> Blue <input type="checkbox"/> Chrome	1x57 W Max	diffused

Hula Hoop_W | Wall Lights | 220-240 V | 1xE27



type	source	optics
<input type="checkbox"/> White <input checked="" type="checkbox"/> 90234 <input type="checkbox"/> Chrome <input checked="" type="checkbox"/> Red	1x57 W Max	diffused



TRIAD /



^ TRIAD WALL LIGHTS
< TRIAD WALL LIGHTS
< TRIAD CEILING LIGHTS

Triad | A movement, an interweaving of geometric elements that fit the wall or ceiling, playing with the room's design, furnishing interiors with their physicality.

Materials: mounting frame made of glossy white coated metal or walnut wood; diffuser made of white silk-screened glass or partly white and partly coloured silk-screened glass.

Triad_P | Pendant Luminaires | 220-240 V | 1xE27

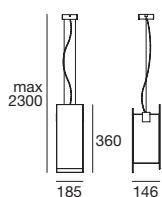
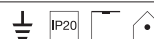

type

White	90210
White	Lilac 90226
White	Walnut W. 90232

source

1x57 W Max

optics

diffused

Triad_P | Pendant Luminaires | 220-240 V | 2xE27

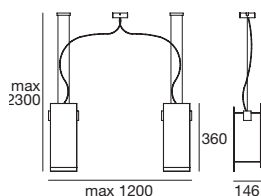
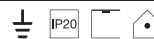

type

White	90211
White	Lilac 90227
White	Walnut W. 90233

source

2x57 W Max

optics

diffused

Triad_S | Ceiling Lights | 220-240 V | 2xE27

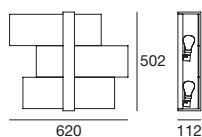

type

White	90208
White	Lilac 90224
White	Walnut W. 90230

source

2x57 W Max

optics

diffused

Triad_S | Ceiling Lights | 220-240 V | 3xE27

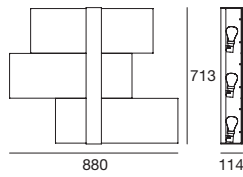

type

White	90209
White	Lilac 90225
White	Walnut W. 90231

source

3x57 W Max

optics

diffused

Triad_W | Wall Lights | 220-240 V | 1xE27

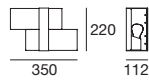

type

White	90206
White	Lilac 90222
White	Walnut W. 90228

source

1x57 W Max

optics

diffused

Triad_W | Wall Lights | 220-240 V | 1xE27

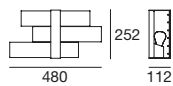

type

White	90207
White	Lilac 90223
White	Walnut W. 90229

source

1x57 W Max

optics

diffused



ECOMOLLA_BILANCIA /



^ ECOMOLLA WALL LIGHTS
< BILANCIA WALL LIGHTS
< BILANCIA CEILING LIGHTS

Ecomolla | A wall or a ceiling light that allows the light to seep out, creating small bright fans above and below it, decorating the wall or the ceiling.

Materials: matt white coated metal mounting frame; transparent glass and white silk-screened glass diffuser.

Bilancia | A wall and ceiling light, or a table lamp, with a sober and elegant style, suitable for all circumstances.

Materials: white sandblasted and silk-screened glass diffuser with chrome-plated details; glossy white or matt grey coated metal mounting frame.

Ecomolla_S | Ceiling Lights | 220-240 V | 1xE27

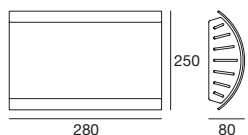
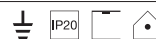

type

White **71641**

source

1x57 W Max

optics

diffused

Ecomolla_S | Ceiling Lights | 220-240 V | 2xE27

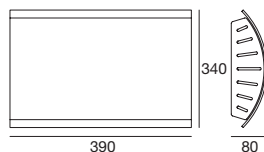
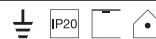

type

White **71642**

source

2x57 W Max

optics

diffused

Ecomolla_W | Wall Lights | 220-240 V | 1xE14

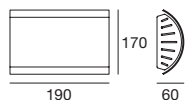
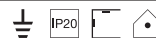

type

White **71640**

source

1x46 W Max

optics

diffused

Bilancia_S | Ceiling Lights | 220-240 V | 2xE27

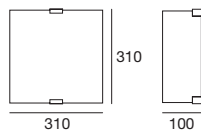
**type**
 5093
source

2x57 W Max

optics

diffused

Bilancia_S | Ceiling Lights | 220-240 V | 2xE27

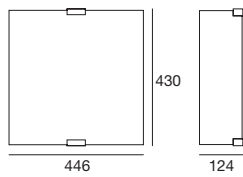
**type**
 5094
source

2x57 W Max

optics

diffused

Bilancia_S | Ceiling Lights | 220-240 V | 3xE27

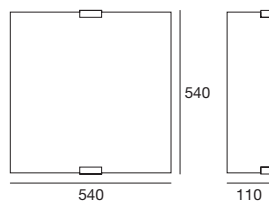
**type**
 5095
source

3x57 W Max

optics

diffused

Bilancia_tab | Table Lamps | 220-240 V | 1xE14

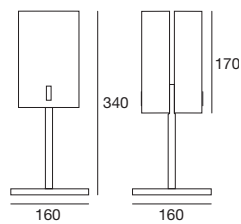
**type**
 5090
source

1x46 W Max

optics

diffused



LINER_LANCIA_DELTA /



^ DELTA CEILING LIGHTS
< LANCIA CEILING LIGHTS
< LANCIA WALL LIGHTS



DELTA WALL LIGHTS
DELTA CEILING LIGHTS



LINER WALL LIGHTS
LINER CEILING LIGHTS

Liner | On the wall or ceiling, a luminaire that rediscovers the joy of simplicity, with a diffuse, soft and enveloping light for every environment.

Materials: glossy white coated metal mounting frame; white silk-screened and sandblasted glass diffuser.

Lancia | A ceiling light and a wall light that transmit the strength and security of the claw of a fierce beast, certain to capture the attention of those who see it.

Materials: glossy white coated metal mounting frame; transparent and white silk-screened glass diffuser.

Delta | A ceiling and a wall light that looks like leavening bread that gives off a fragrance made of light, velvety and enveloping.

Materials: glossy white coated metal mounting frame; white or amber sandblasted silk-screened glass diffuser.

Liner_S | Ceiling Lights | 220-240 V | 1xE27

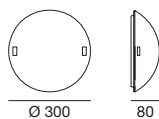
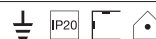

type

White Nickel **71883**

source

1x46 W Max

optics

diffused

Liner_S | Ceiling Lights | 220-240 V | 2xE27

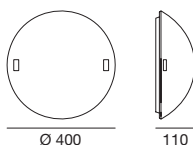
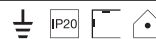

type

White Nickel **71886**

source

2x46 W Max

optics

diffused

Liner_S | Ceiling Lights | 220-240 V | 3xE27

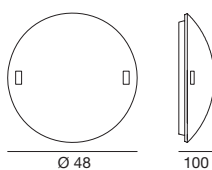
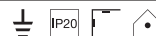

type

White Nickel **71889**

source

3x46 W Max

optics

diffused

Liner_S | Ceiling Lights | 220-240 V | 4xE27

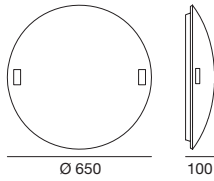

type

White **Nickel** **71892**

source

4x46 W Max

optics

diffused

Liner_W | Wall Lights | 220-240 V | 1xE27

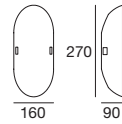

type

White **Nickel** **71877**

source

1x46 W Max

optics

diffused

Liner_W | Wall Lights | 220-240 V | 1xE27

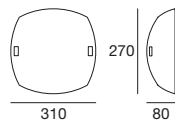

type

White **Nickel** **71880**

source

2x46 W Max

optics

diffused

Lancia_S | Ceiling Lights | 220-240 V | 1xE27

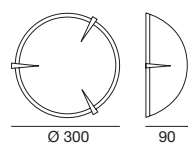

type

White **Chrome** **73665**

source

1x46 W Max

optics

diffused

Lancia_S | Ceiling Lights | 220-240 V | 2xE27

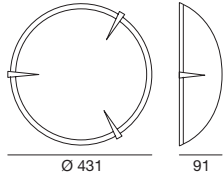

type

White Chrome **73666**

source

2x46 W Max

optics

diffused

Lancia_S | Ceiling Lights | 220-240 V | 3xE27

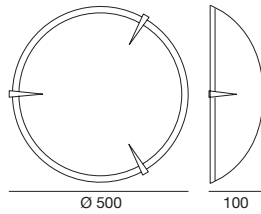

type

White Chrome **73667**

source

3x46 W Max

optics

diffused

Lancia_W | Wall Lights | 220-240 V | 1xE27

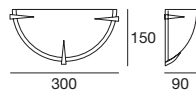
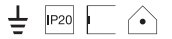

type

White **73668**

source

1x46 W Max

optics

diffused

Delta_S | Ceiling Lights | 220-240 V | 1xE27

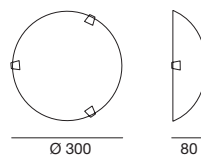

type

White Nickel **3430**
White Amber **3440**

source

1x46 W Max

optics

diffused

Delta_S | Ceiling Lights | 220-240 V | 2xE27

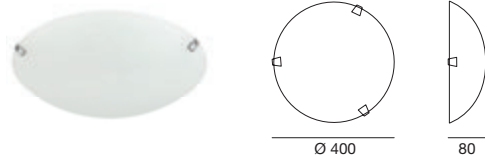

type

White	Nickel	3431
White	Amber	3441

source

2x46 W Max

optics

diffused

Delta_S | Ceiling Lights | 220-240 V | 3xE27

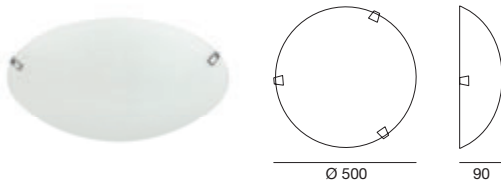

type

White	Nickel	3432
White	Amber	3442

source

3x46 W Max

optics

diffused

Delta_W | Wall Lights | 220-240 V | 1xE27

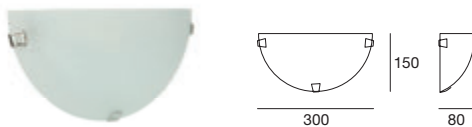

type

White	Nickel	3435
White	Amber	3445

source

1x46 W Max

optics

diffused



LUMINOSA /



LUMINOSA WALL LIGHTS
LUMINOSA CEILING LIGHTS

Luminosa | The strength and geometry of a simple shape but one of great impact, which collects the light to spread it softly in every direction.

Materials: translucent white linear polyethylene casing; transparent glass and white silk-screened glass diffuser.

Luminosa_S | Ceiling Lights | 220-240 V | 2xE27

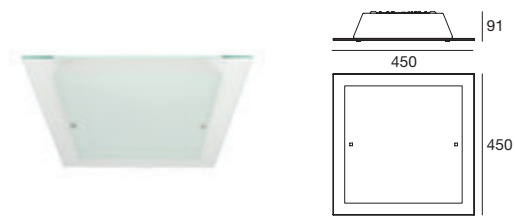

type	source	optics
White 71691	2x20 W Max	diffused

Luminosa_S | Ceiling Lights | 220-240 V | 3xE27

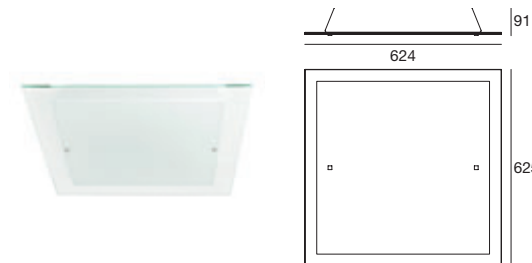

type	source	optics
White 71692	3x20 W Max	diffused

Luminosa_W | Wall Lights | 220-240 V | 1xE27



type	source	optics
White 71690	1x20 W Max	diffused



ONDA_MARINA_ICEBERG /



^ ONDA WALL LIGHTS
< ICEBERG CEILING LIGHTS



MARINA WALL LIGHTS

Onda | A fantasy of curves and folds, like a scarf caressed by the wind, a light wave that intrigues with its dynamism.

Materials: glossy white coated metal mounting frame; white or amber silk-screened and sandblasted glass diffuser.

Marina | Like a sail filled by the sea breeze, this versatile luminaire reassures with its appearance, illuminating every corner of the house.

Materials: mounting frame made of glossy white or matt grey coated metal or of cherry wood; casing made of matt grey coated metal or of cherry wood; white sandblasted and silk-screened glass diffuser with chrome-plated or cherry wood details.

Iceberg | A huge block of ice surfaces from the depths of the sea, driven by a light energy that enhances its shape and majesty.

Materials: glossy white coated metal mounting frame; white sandblasted glass diffuser.

Onda_S | Ceiling Lights | 220-240 V | 2xE27

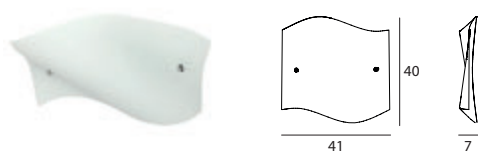
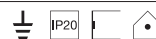

type

White	2400
Amber	2403

source

2x46 W Max

optics

diffused

Onda_S | Ceiling Lights | 220-240 V | 2xE27

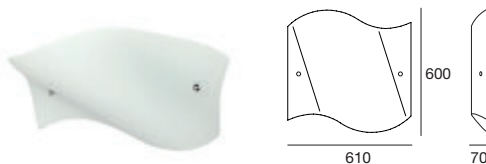
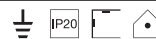

type

White	2405
Amber	2408

source

2x46 W Max

optics

diffused

Onda_W | Wall Lights | 220-240 V | 1xE27



type

White	358B881
Amber	358B921

source

1x46 W Max

optics

diffused

Onda_W | Wall Lights | 220-240 V | 2xE27

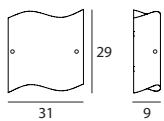

type

White	327B881
Amber	327B921

source

2x46 W Max

optics

diffused

Marina_S | Ceiling Lights | 220-240 V | 1xE27

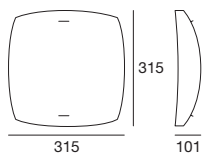
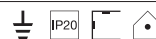

type

White	Chrome	2920
White	Cherry W	2940

source

1x57 W Max

optics

diffused

Marina_S | Ceiling Lights | 220-240 V | 2xE27

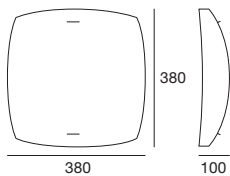
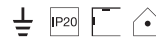

type

White	Chrome	2922
White	Cherry W	2942

source

2x57 W Max

optics

diffused

Marina_S | Ceiling Lights | 220-240 V | 2xE27

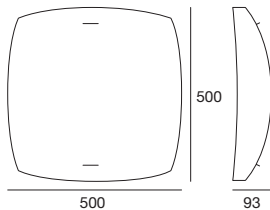
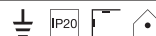

type

White	Chrome	2924
White	Cherry W	2944

source

2x57 W Max

optics

diffused

Marina_W | Wall Lights | 220-240 V | 1xE27

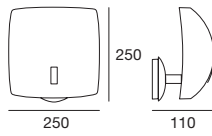
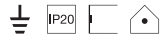

type

White	Chrome	2925
White	Glasy W	2945

source

1x46 W Max

optics

diffused

Iceberg_S | Ceiling Lights | 220-240 V | 2xE27

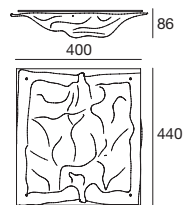

type

White	90214
-------	-------

source

2x57 W Max

optics

diffused

Iceberg_S | Ceiling Lights | 220-240 V | 3xE27

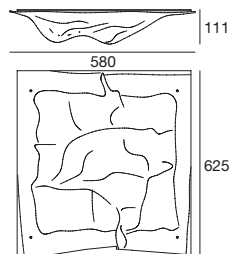

type

White	90215
-------	-------

source

3x57 W Max

optics

diffused

Iceberg_W | Wall Lights | 220-240 V | 2xE27

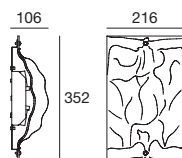

type

White	90250
-------	-------

source

2x46 W Max

optics

diffused



WALLY_MET WALLY /



^ WALLY_WALL LIGHTS
< MET WALLY_WALL LIGHTS

Wally | The meeting between different materials and the expressive force it releases creates a ceiling or wall light that decorates with personality.

Materials: glossy white coated metal mounting frame; casing made of matt white or rust colour coated metal or with chrome-plated or brushed nickel finish; white silk-screened and sandblasted glass diffuser.

Met Wally | A transparency that by thickening, turns into a light that expands into space, from the wall and from the ceiling.

Materials: matt white coated metal mounting frame; casing made of metal with decorative elements with brushed nickel finish, or of cherry wood; diffuser made of transparent and white silk-screened glass.

Wally | Wall Lights | 220-240 V | 1xE27

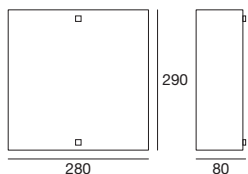

type

White **71570**

source

1x46 W Max

optics

diffused

Wally | Wall Lights | 220-240 V | 2xE27

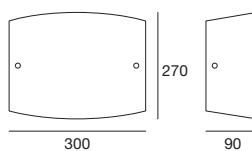

type

White **321B881**

source

2x46 W Max

optics

diffused

Met Wally | Wall Lights | 220-240 V | 1xE27

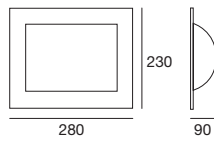
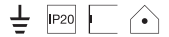

type

White	537BRA881
Chrome	537K881
Nickel	537NS881
Rust	575RU881

source

1x57 W Max

optics

diffused

Met Wally | Wall Lights | 220-240 V | 2xE27

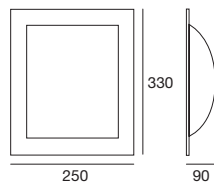

type

White	539BRA881
Chrome	539K881
Nickel	539NS881
Rust	576RU881

source

2x57 W Max

optics

diffused

Met Wally | Wall Lights | 220-240 V | 3xE27

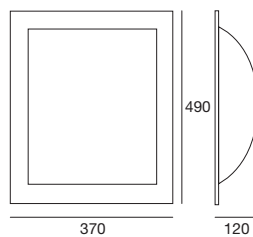

type

White	536BRA881
Chrome	536K881
Nickel	536NS881
Rust	577RU881

source

3x57 W Max

optics

diffused



MATRIOSKA /



- ^ MATRIOSKA WALL LIGHTS
- < MATRIOSKA WALL LIGHTS
- < MATRIOSKA PENDANT LUMINAIRES

Matrioska | A light pulses and expands into a soft shell that leaves it free to express itself in all its whiteness, hovering from the ceiling or in midair.

Materials: white wrinkle-effect or gold-leaf effect coated metal casing; white sandblasted and silk-screened glass diffuser.

Matrioska_W | Wall Lights | 220-240 V | 1xE27

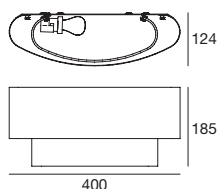

type

White	90240
Gold	90245

source

1x46 W Max

optics

diffused

Matrioska_W | Wall Lights | 220-240 V | 2xE27

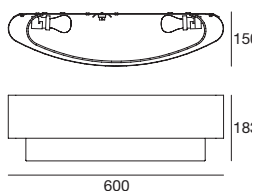

type

White	90241
Gold	90246

source

2x46 W Max

optics

diffused

Matrioska_P | Pendant Luminaires | 220-240 V | 3xE27

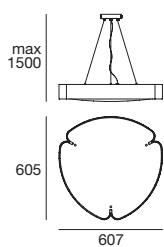
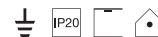

type

White	90244
Gold	90249

source

3x46 W Max

optics

diffused

Matrioska_S | Ceiling Lights | 220-240 V | 2xE27

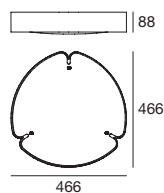
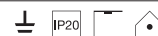

type

White	90242
Gold	90247

source

2x46 W Max

optics

diffused

Matrioska_S | Ceiling Lights | 220-240 V | 3xE27

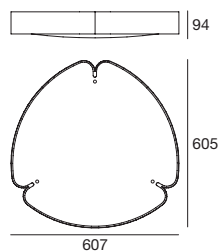
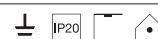

type

White	90243
Gold	90248

source

3x46 W Max

optics

diffused



MAMI /



^ MAMI CEILING LIGHTS
< MAMI PENDANT LUMINAIRES



MAMI WALL LIGHTS

Mami | Light in different models, with a design that evokes femininity and prettiness, like a long skirt moved by wind.

Matériaux : corps en céramique blanche, enrichi par un motif décoratif peint en marron; monture en métal verni rouille ; diffuseur en verre sablé blanc.

Mami_P1 | Pendant Luminaires | 220-240 V | 1xE14

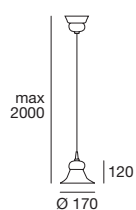
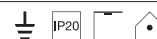

type

Rust 2644

source

1x30 W Max

optics

diffused

Mami_P1 | Pendant Luminaires | 220-240 V | 1xE27

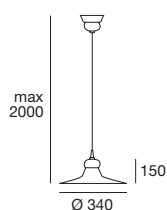
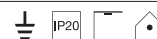

type

Rust 2645

source

1x46 W Max

optics

diffused

Mami_P1 | Pendant Luminaires | 220-240 V | 1xE27

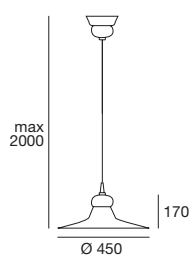
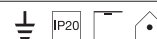

type

Rust 2638

source

1x46 W Max

optics

diffused

Mami_P1 | Pendant Luminaires | 220-240 V | 1xE27

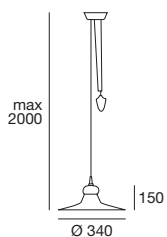
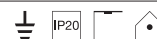

type

Rust 2646

source

1x46 W Max

optics

diffused

Mami_P2 | Pendant Luminaires | 220-240 V | 2xE27

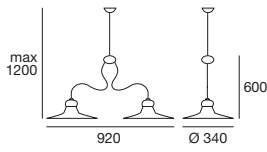
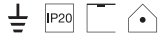

type

Rust 2639

source

2x46 W Max

optics

diffused

Mami_P3 | Pendant Luminaires | 220-240 V | 3xE14

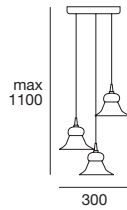
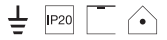

type

Rust 2647

source

3x30 W Max

optics

diffused

Mami_S3 | Ceiling Lights | 220-240 V | 3xE14

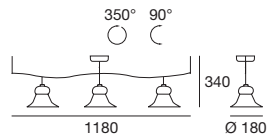

type

Rust 2653

source

3x30 W Max

optics

diffused

Mami_S3 | Ceiling Lights | 220-240 V | 3xE14

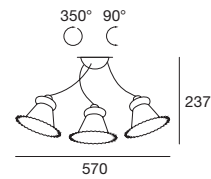

type

Rust 2649

source

3x46 W Max

optics

diffused

Mami_S5 | Ceiling Lights | 220-240 V | 5xE14

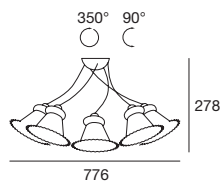

type

Rust 2657

source

5x30 W Max

optics

diffused

Mami_W1 | Wall Lights | 220-240 V | 1xE14

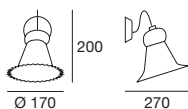

type	source	optics
Rust 2655	1x30 W Max	diffused

Mami_W1 | Wall Lights | 220-240 V | 1xE14

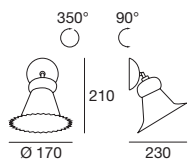

type	source	optics
Rust 2641	1x30 W Max	diffused

Mami_W2 | Wall Lights | 220-240 V | 2xE14

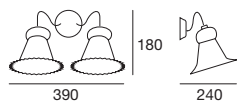

type	source	optics
Rust 2654	2x30 W Max	diffused

Mami_W2 | Wall Lights | 220-240 V | 2xE14

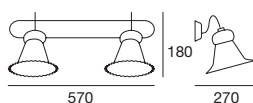
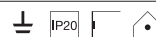

type	source	optics
Rust 2656	2x30 W Max	diffused

Mami_tab | Table Lamps | 220-240 V | 1xE14

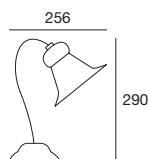

type	source	optics
Rust 2642	1x30 W Max	diffused



ARTIC_SYBERIA /



^ ARTIC PENDANT LUMINAIRES
< ARTIC CEILING LIGHTS
< ARTIC WALL LIGHTS



ARTIC PENDANT LUMINAIRES



SYBERIA WALL LIGHTS

SYBERIA WALL LIGHTS



Artic | A ceiling light and wall light that evoke the strength of ice, with its reflections and its cold but enchanting appearance.

Materials: metal mounting frame with chrome-plated finish; finely decorated transparent glass diffuser.

Syberia | The sensation of observing light emerge from the depths of a glacier, pure and strong, for a ceiling and a wall light that furnishes with discretion.

Materials: glossy white coated metal mounting frame; transparent crystal diffuser with amber details.

Artic_P | Pendant Luminaires | 220-240 V | 1xE27

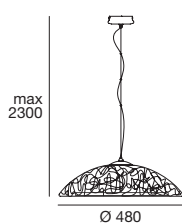
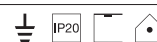

type

Transp. **6931**

source

1x57 W Max

optics

diffused

Artic_P | Pendant Luminaires | 220-240 V | 3xG9

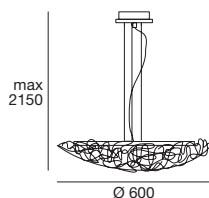
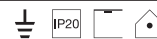

type

Transp. **4649**

source

3x48 W Max

optics

diffused

Artic_S | Ceiling Lights | 220-240 V | 1xG9

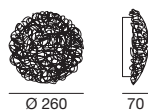
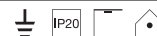

type

Transp. **4650**

source

1x48 W Max

optics

diffused

Artic_S | Ceiling Lights | 220-240 V | 3xG9

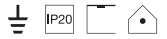

type

Transp. 4652

source

3x33 W Max

optics

diffused

Artic_S | Ceiling Lights | 220-240 V | 4xG9



type

Transp. 4654

source

4x33 W Max

optics

diffused

Artic_S | Ceiling Lights | 220-240 V | 6xG9

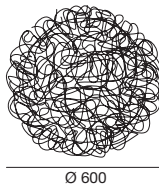
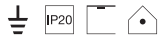

type

Transp. 4664

source

6x33 W Max

optics

diffused

Artic_S | Ceiling Lights | 220-240 V | 2xE27

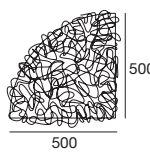

type

Transp. 4663

source

2x46 W Max

optics

diffused

Artic_W | Wall Lights | 220-240 V | 1xG9

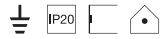

type	source	optics
Transp. 4668	1x33 W Max	diffused



Artic_W | Wall Lights | 220-240 V | 2xG9

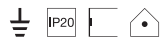

type	source	optics
Transp. 4669	2x33 W Max	diffused



Artic_W | Wall Lights | 220-240 V | 1xE27



type	source	optics
Transp. 4662	1x46 W Max	diffused



Syberia_S | Ceiling Lights | 220-240 V | 1xE27



type	source	optics
Transp. 4480	1x57 W Max	diffused



Syberia_S | Ceiling Lights | 220-240 V | 1xE27

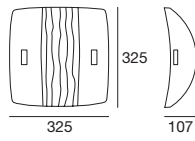
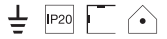

type

Transp. Yellow 4490

source

1x57 W Max

optics

diffused

Syberia_S | Ceiling Lights | 220-240 V | 2xE27

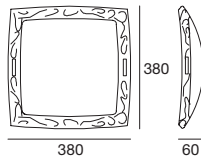

type

Transp. 4481

source

2x57 W Max

optics

diffused

Syberia_S | Ceiling Lights | 220-240 V | 2xE27

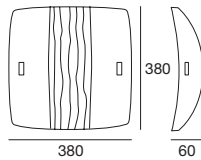

type

Transp. Yellow 4482

source

2x57 W Max

optics

diffused

Syberia_S | Ceiling Lights | 220-240 V | 2xE27

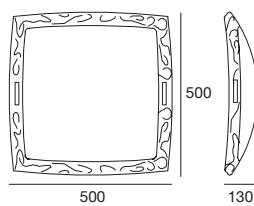

type

Transp. 4482

source

2x57 W Max

optics

diffused

Syberia_S | Ceiling Lights | 220-240 V | 2xE27

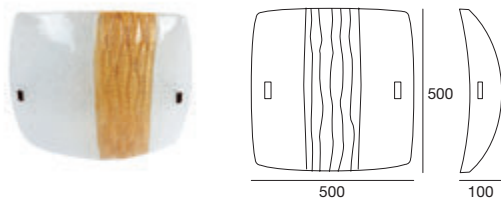
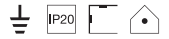

type

Transp. **Yellow** **4492**

source

2x57 W Max

optics

diffused

Syberia_W | Wall Lights | 220-240 V | 1xE27

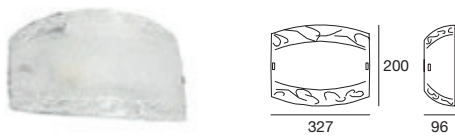
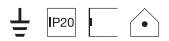

type

Transp. **4514**

source

1x46 W Max

optics

diffused

Syberia_W | Wall Lights | 220-240 V | 1xE27

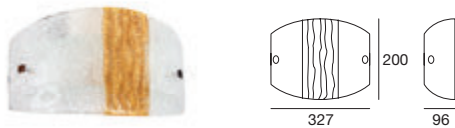

type

Transp. **Yellow** **4524**

source

1x46 W Max

optics

diffused



OH! IN /



OH! PENDANT LUMINAIRES



OH!_PMX PENDANT LUMINAIRES



OHI_PMX PENDANT LUMINAIRES



OH! PENDANT LUMINAIRES



OHI CEILING LIGHTS

OH! FLOOR LAMPS





Oh_IN | The perfection of the sphere, the naturalness of light, a pleasant presence in every space: alone or in company, a suspension light that knows how to decorate and illuminate with simplicity and spontaneity.

Materials: white linear polyethylene casing for diffused lighting; white linear polyethylene base.

Oh!_P | Pendant Luminaires | 220-240 V

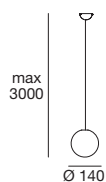

new

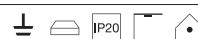

topLED 6 W 350 mA

colour

optics

White CRI 90 **10114**

3000 K 726 lm

diffused

new



topLED 8 W 350 mA

colour

optics

White CRI 90 **10135**

3000 K 1002 lm

diffused

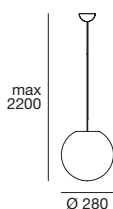

new



topLED 15 W 350 mA

colour

optics

White CRI 90 **10136**

3000 K 1893 lm

diffused

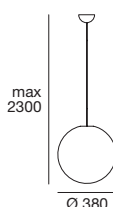

new



topLED 20 W 500 mA

colour

optics

White CRI 90 **10137**

3000 K 2652 lm

diffused

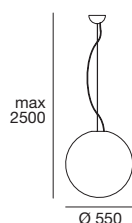

new



topLED 29 W 700 mA

colour

optics

White CRI 90 **10138**

3000 K 3674 lm

diffused

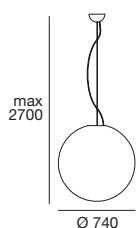

Oh!_PMX | Pendant Luminaires | 220-240 V | topLED 17 W 350 mA

new

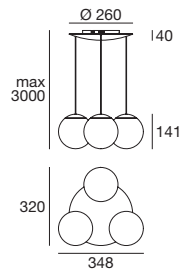

type

White CRI 90 **10117**

colour

3000 K 2181 lm

optics

diffused

Oh!_S | Ceiling Lights | 220-240 V

new



topLED 8 W 350 mA

White CRI 90 **10131**

colour

3000 K 1002 lm

optics

diffused

new



topLED 15 W 350 mA

White CRI 90 **10132**

colour

3000 K 1893 lm

optics

diffused

new



topLED 20 W 500 mA

White CRI 90 **10133**

colour

3000 K 2652 lm

optics

diffused

new

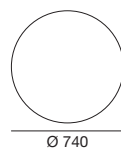

topLED 29 W 700 mA

White CRI 90 **10134**

colour

3000 K 3674 lm

optics

diffused

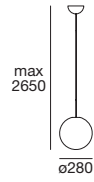

1xE27

White 10101

source

1x30 W Max

optics

diffused

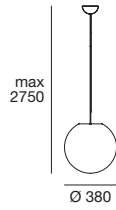

1xE27

White 10103

source

1x46 W Max

optics

diffused

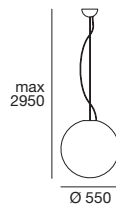

1xE27

White 10105

source

1x46 W Max

optics

diffused

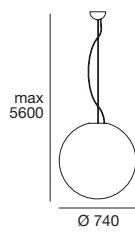

1xE27

White 10107

source

1x57 W Max

optics

diffused

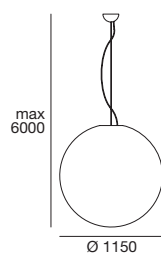

1xE27

White 10111

source

1x77 W Max

optics

diffused

Oh!_PM | Pendant Luminaires | 220-240 V | 3xE27

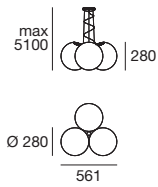
**type**

White 10220

source

3x30 W Max

optics

diffused

Oh!_PM | Pendant Luminaires | 220-240 V | 3xE27

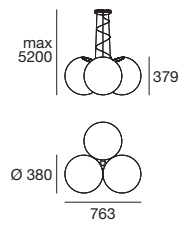
**type**

White 10221

source

3x46 W Max

optics

diffused

Oh!_PM | Pendant Luminaires | 220-240 V | 7xE27

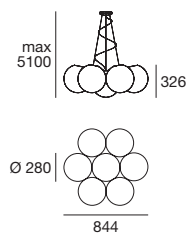
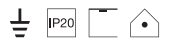
**type**

White 10224

source

7x30 W Max

optics

diffused

Oh!_PM | Pendant Luminaires | 220-240 V | 7xE27

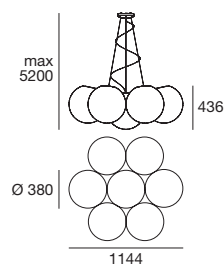
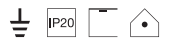
**type**

White 10225

source

7x46 W Max

optics

diffused

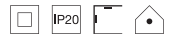

1xE27

White 10122

source

1x30 W Max

optics

diffused



1xE27

White 10124

source

1x46 W Max

optics

diffused



1xE27

White 10126

source

1x46 W Max

optics

diffused

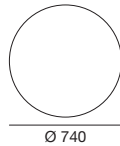

1xE27

White 10128

source

1x57 W Max

optics

diffused

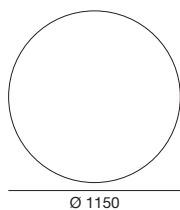

1xE27

White 10130

source

1x77 W Max

optics

diffused

Oh!_FL | Floor Lamp | 220-240 V

**1xE27**White **10100****source**

1x30 W Max

optics

diffused

**1xE27**White **10102****source**

1x46 W Max

optics

diffused

**1xE27**White **10104****source**

1x46 W Max

optics

diffused

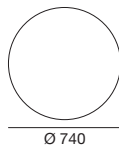
**1xE27**White **10106****source**

1x57 W Max

optics

diffused

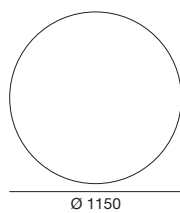
**1xE27**White **10110****source**

1x77 W Max

optics

diffused



OHPS_IN /



OHPS PENDANT LUMINAIRES

Ohps_IN | The perfection of the half-sphere, the naturalness of light, a pleasant presence in every space: whether alone or in company, a luminaire that knows how to decorate and illuminate with simplicity and spontaneity.

Materials: translucent white linear polyethylene casing for diffused lighting; base made of matt white coated metal and of white linear polyethylene.

Ohps_P | Pendant Luminaires | 220-240 V | 1xE27

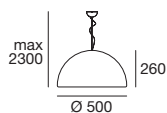
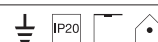

type

White **10382**

source

1x46 W Max

optics

diffused

Ohps_P | Pendant Luminaires | 220-240 V | 1xE27

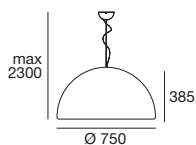
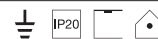

type

White **10383**

source

1x46 W Max

optics

diffused

Ohps_S | Ceiling Lights | 220-240 V | 1xE27

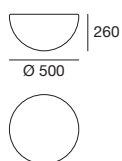

type

White **10386**

source

1x30 W Max

optics

diffused

Ohps_S | Ceiling Lights | 220-240 V | 1xE27

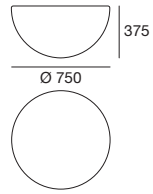
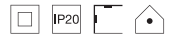

type

White **10387**

source

1x46 W Max

optics

diffused

Ohps_FL | Floor Lamps | 220-240 V | 1xE27

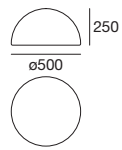

type

White **10380**

source

1x30 W Max

optics

diffused

Ohps_FL | Floor Lamps | 220-240 V | 1xE27

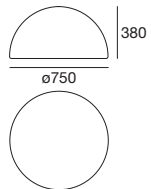

type

White **10381**

source

1x46 W Max

optics

diffused



OH! SMASH_IN /



OH! SMASH FLOOR LAMPS

Oh! Smash_IN | Technologically advanced light globes with round shapes that fill the room with an enveloping, welcoming light.

Materials: base in white wrinkle-effect coated metal or in white polyethylene; polyethylene diffuser.

Oh! Smash_P | Pendant Luminaires | 220-240 V | 1xE27

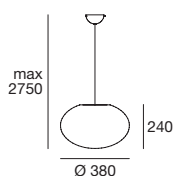

type

White 10213

source

1x30 W Max

optics

diffused

Oh! Smash_P | Pendant Luminaires | 220-240 V | 1xE27

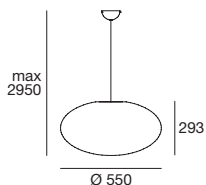
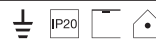

type

White 10216

source

1x46 W Max

optics

diffused

Oh! Smash_S | Ceiling Lights | 220-240 V | 1xE27

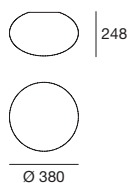
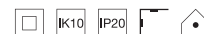

type

White 10214

source

1x30 W Max

optics

diffused

Oh! Smash_S | Ceiling Lights | 220-240 V | 1xE27

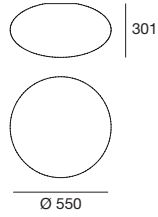
**type**White **10217****source**

1x46 W Max

optics

diffused

Oh! Smash_FL | Floor Lamp | 220-240 V | 1xE27

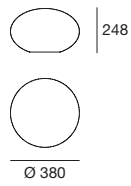
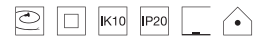
**type**White **10215****source**

1x30 W Max

optics

diffused

Oh! Smash_FL | Floor Lamp | 220-240 V | 1xE27

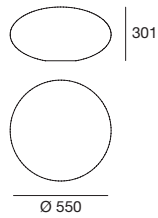
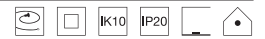
**type**White **10218****source**

1x46 W Max

optics

diffused



new

STRAIGHT_W /



STRAIGHT WALL LIGHTS

STRAIGHT WALL LIGHTS



Straght_W | Minimal applique, thin stem with a delicate lighting created for mirrors or artworks. Its elegant finishes make it universal.

Materials: white, chrome or brown ABS setting, polycarbonate diffuser.

Straght_W | Wall Lights | 220-240 V | topLED 13 W 700 mA

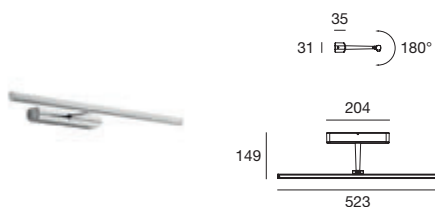

new



type

White	CRI 90	8208
Black	CRI 90	8210
Chrome	CRI 90	8265
Burned	CRI 90	8267

colour

2700 K 1444 lm

optics

diffused

Straght_W | Wall Lights | 220-240 V | topLED 19 W 1000 mA

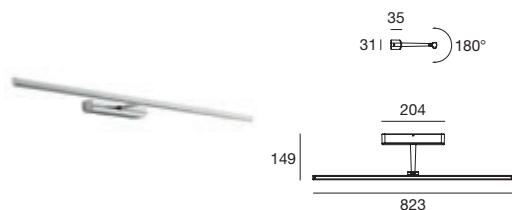

new



type

White	CRI 90	8209
Black	CRI 90	8211
Chrome	CRI 90	8266
Burned	CRI 90	8268

colour

2700 K 2080 lm

optics

diffused



new

HALFPIPE /



HALFPIPE WALL LIGHTS

HALFPIPE WALL LIGHTS







Halfpipe | Light surfs over the internal metal curved surface and softly spreads on space below. Lighting is only where needed: a full cooperation between shape and function.

Materials: polished aluminum setting, or white or champagne wrinkled coating.
Silicone diffuser.

Halfpipe | Wall Lights | 220-240 V | topLED 9 W 500 mA



new



type

White	CRI 90	8390
Polish Al.	CRI 90	8391
Champ.	CRI 90	8392

colour

3000 K 1050 lm

optics

diffused

Halfpipe | Wall Lights | 220-240 V | topLED 12 W 350 mA

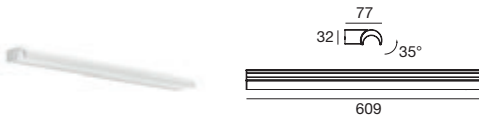

new



type

White	CRI 90	8395
Polish Al.	CRI 90	8396
Champ.	CRI 90	8397

colour

3000 K 1511 lm

optics

diffused

Halfpipe | Wall Lights | 220-240 V | topLED 18 W 1000 mA

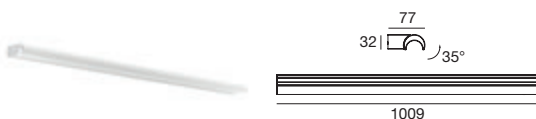

new



type

White	CRI 90	8400
Polish Al.	CRI 90	8401
Champ.	CRI 90	8402

colour

3000 K 2064 lm

optics

diffused



KIOO /



KIOO WALL LIGHTS

KIOO WALL LIGHTS



Kioo | A wall light featuring a clean, engaging minimalist look designed to produce lighting that inspires inner care, well-being and quiet emotion.

Materials: casing in white wrinkle-effect coated aluminium or with glossy finish; opaline polycarbonate diffuser.

Kioo | Wall Lights | 220-240 V | topLED 14 W 350 mA

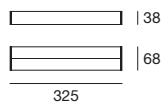
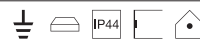

type

White	CRI 83	7904
Anod. Al.	CRI 83	7905

colour

3000 K 1449 lm

optics

diffused

Kioo | Wall Lights | 220-240 V | topLED 28 W 350 mA



type

White	CRI 83	7906
Anod. Al.	CRI 83	7907

colour

3000 K 2898 lm

optics

diffused



SKINNY /



^ PRIME WALL LIGHTS
< SKINNY WALL LIGHTS





SKINNY WALL LIGHTS

Skinny | Bright shelf light with an elegant, clean style combining state-of-the-art technology and minimalist refinement.

Materials: casing in white wrinkle-effect coated aluminium or with glossy finish; polymethylmethacrylate diffuser with laser silk-screen printing.

Skinny | Wall Lights | 220-240 V | topLED 14 W 350 mA

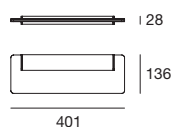

type

White	CRI 80	7908
Anod. Al.	CRI 80	7909

colour

3000 K 1449 lm

optics

diffused

Skinny | Wall Lights | 220-240 V | topLED 28 W 350 mA

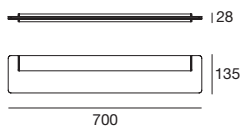

type

White	CRI 80	7910
Anod. Al.	CRI 80	7911

colour

3000 K 2898 lm

optics

diffused



new

CIRCULAR /

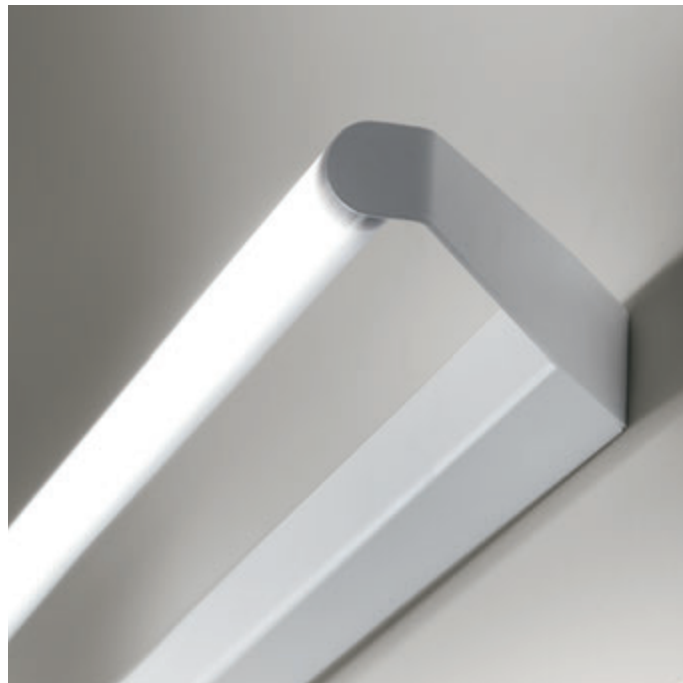

CIRCULAR WALL LIGHTS

CIRCULAR WALL LIGHTS



Circular | A wall light with a thin casing, ideal for illuminating a mirror in its full length with an elongated cylindrical diffuser.

Materials: white wrinkled or chrome coating aluminum setting, polymethylmethacrylate diffuser.

Circular | Wall Lights | 220-240 V | topLED 8 W 500 mA

new



type

colour

optics

White CRI 90 **8405**

3000 K 1075 lm

diffused

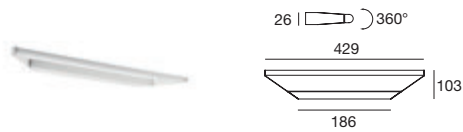

Circular | Wall Lights | 220-240 V | topLED 11 W 350 mA

new



type

colour

optics

White CRI 90 **8409**

3000 K 1511 lm

diffused

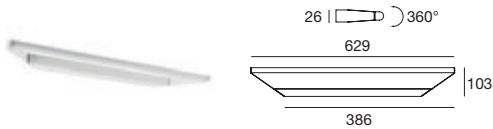

Circular | Wall Lights | 220-240 V | topLED 19 W 350 mA

new



type

colour

optics

White CRI 90 **8413**

3000 K 2266 lm

diffused

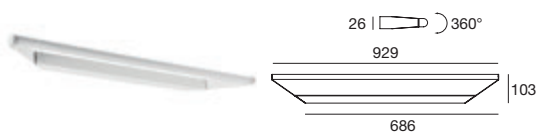



ALOHA_PRIME /



^ PRIME WALL LIGHTS
< ALOHA WALL LIGHTS

PRIME WALL LIGHTS



Aloha | A ring of light celebrating minimalism and simplicity, raising them to the status of elements of interior decoration that accompany soft, delicate lighting.

Materials: white wrinkle-effect coated aluminium casing and white wrinkle-effect coated polycarbonate base, or aluminium casing with chrome finish and polycarbonate base with chrome finish; sandblasted polycarbonate diffuser.

Prime | A wall light with a curved and sinuous casing, with a double diffuse light emission.

Materials: casing made of white wrinkle-effect coated metal, chrome-plated metal or with concrete finish; white sandblasted polycarbonate diffuser.

Aloha | Wall Lights | 220-240 V | topLED 14 W 700 mA

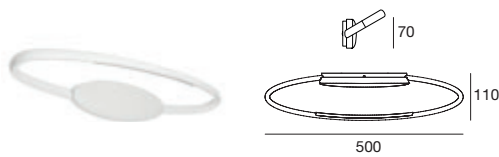

type

White	CRI 90	7914
Chrome	CRI 90	7915

colour

3000 K 1488 lm

optics

diffused

Prime | Wall Lights | 220-240 V | topLED 10 W 250 mA

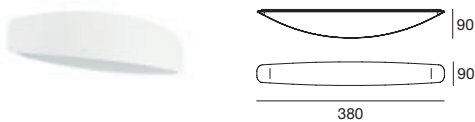

type

White	CRI 80	7812
Chrome	CRI 80	7811
Concrete	CRI 80	7815

colour

3000 K 1021 lm

optics

diffused

Prime | Wall Lights | 220-240 V | topLED 13 W 700 mA

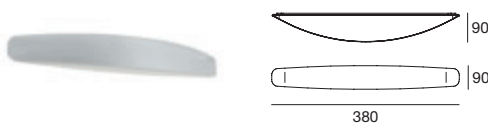

type

White	CRI 80	7814
Chrome	CRI 80	7813
Concrete	CRI 80	7816

colour

3000 K 1772 lm

optics

diffused



SOLID /



SOLID WALL LIGHTS



SOLID WALL LIGHTS



Solid | A classical wall light with squared lines and a satin-finished diffuser for homogeneous and comfortable light.

Materials: grey coated or chrome-plated metal casing; white satin-finished polymethylmethacrylate diffuser.

Solid | Wall Lights | 220-240 V | 1xG5



type	source	optics
Grey 3695	Fluorescent 1x24 W (included)	diffused



Solid | Wall Lights | 220-240 V | 1xG5



type	source	optics
Chrome 3694	Fluorescent 1x39 W (included)	diffused

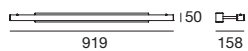



GOCCIA_BOLL /



^ GOCCIA TABLE LAMPS
< GOCCIA WALL LIGHTS



GOCCIA WALL LIGHTS



BOLL WALL LIGHTS

Boll | A base with stylish finishes and a sandblasted diffuser create a luminaire that looks like bright bubbles that emerge from either the wall or the ceiling.

Materials: casing made of chrome-plated metal or glass with gold- or silver-leaf effect; white and transparent sandblasted glass diffuser.

Goccia | A ceiling or wall light with an organic form, which evokes the appearance of a stone smoothed by the flow of water and time.

Materials: white satin-finished polycarbonate mounting frame; white glass diffuser.

Boll_1 | Ceiling_Wall Lights | 220-240 V | 1xG9

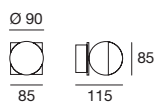

type	source	optics
White 5008	1x33 W Max	diffused

Boll_2 | Ceiling_Wall Lights | 220-240 V | 2xG9

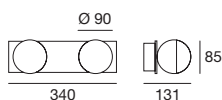

type	source	optics
White 5009	2x33 W Max	diffused

Boll_3 | Ceiling_Wall Lights | 220-240 V | 3xG9

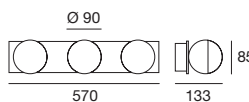

type	source	optics
White 5010	3x33 W Max	diffused

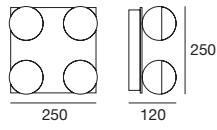
Boll_4 | Ceiling_Wall Lights | 220-240 V | 4xG9**type**White **5011****source**

4x33 W Max

optics

diffused

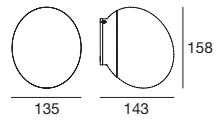
Goccia_W | Wall Lights | 220-240 V | topLED 5 W 18 mA**type**White CRI 80 **7241****colour**

3000 K 400 lm

optics

diffused

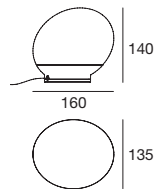
Goccia_tab | Table Lamps | 220-240 V | topLED 5 W 18 mA**type**White CRI 80 **7243****colour**

3000 K 400 lm

optics

diffused



FOTIS /



FOTIS WALL LIGHTS



FOTIS WALL LIGHTS

Fotis | The physicality of the metal does not contrast with that of the glass but espouses it, in a union of light and matter that gives character to every mirror or wall.

Materials: metal casing with chrome-plated finish; transparent and partly sandblasted glass diffuser.

Fotis_R | Wall Lights | 220-240 V | 2xG9

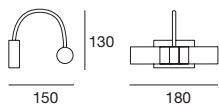

type

Chrome 3672

source

Halogen 2x33 W (included)

optics

diffused

Fotis_R | Wall Lights | 220-240 V | 4xG9

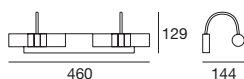

type

Chrome 3674

source

Halogen 4x33 W (included)

optics

diffused

Fotis_R | Wall Lights | 220-240 V | 2xG9

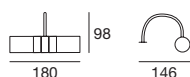

type

Chrome 3670

source

Halogen 2x33 W (included)

optics

diffused

accessories



Kit 01
Bracket

Fotis_fix | Wall Lights | 220-240 V | 1xG9

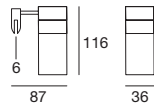

type

Chrome **3260**

source

Halogen 1x33 W (included)

optics

diffused

Fotis_fix | Wall Lights | 220-240 V | 2xG9

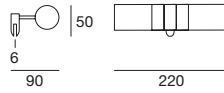

type

Chrome **3261**

source

Halogen 2x33 W (included)

optics

diffused

Fotis_fix | Wall Lights | 220-240 V | 2xG9

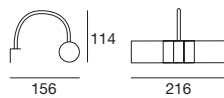

type

Chrome **3276**

source

Halogen 2x33 W (included)

optics

diffused

Fotis_fix | Wall Lights | 220-240 V | 2xG9

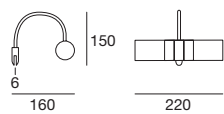

type

Chrome **3262**

source

Halogen 2x33 W (included)

optics

diffused

Fotis_Q | Wall Lights | 220-240 V | 2xG9

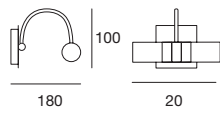
**type**Chrome **3272**Nickel **3372****source**

Halogen 2x33 W (included)

optics

diffused

Fotis_Q | Wall Lights | 220-240 V | 1xG9

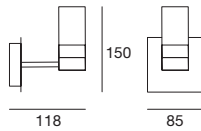
**type**Chrome **3270****source**

Halogen 1x33 W (included)

optics

diffused

Fotis_Q | Wall Lights | 220-240 V | 2xG9

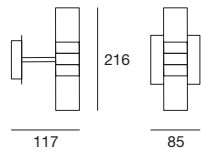
**type**Chrome **3271****source**

Halogen 2x33 W (included)

optics

diffused

Fotis_mirror | Wall Lights | 220-240 V | 1xGU10

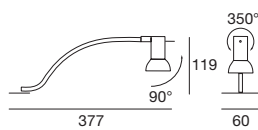
**type**Chrome **1156****source**

1x42 W (included)

optics

diffused



ELIPSE_DICE_CUBIC /



^ DICE WALL LIGHTS
< CUBIC WALL LIGHTS



ELIPSE WALL LIGHTS

Elipse | A wall light with a simple and reassuring appearance, that illuminates with a double light emission, in a diffused manner.

Materials: transparent polycarbonate casing; white glass and white sandblasted glass diffuser.

Dice | One die illuminates the wall joyfully: a fun double emission wall light.

Materials: transparent polycarbonate casing; white glass and white sandblasted glass diffuser.

Cubic | A perfectly cube-shaped form, a simplicity that attracts and intrigues, for a wall light that integrates well in environments of every style.

Materials: white silk-screened glass diffuser; base made of chrome-plated metal, wenge or cherry wood or of red, black or white coloured glass.

Elipse | Wall Lights | 220-240 V | 1xG9

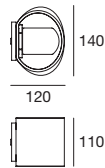

type

White **6905**

source

1x7 W (included)

optics

diffused

Dice | Wall Lights | 220-240 V | topLED 17 W 500 mA

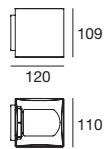

type

White **6906**

source

1x7 W (included)

optics

diffused

Cubic | Wall Lights | 220-240 V | 1xG9

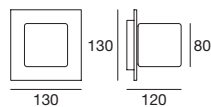

type

Chrome **6410**

White **6413**

Wengé **6414**

source

1x33 W (included)

optics

diffused



MONO SYSTEM /



^ CIRCULAR-C CABLE SYSTEM
< ORIENT-C CABLE SYSTEM

OHI-C CABLE SYSTEM





TRIX-C CABLE SYSTEM

Mono System | A tension wire, placed between two walls, provides support and power to the lighting fixtures: it forms an installation level from which both accent and ambient lighting can be created to meet any need, also using different light sources.

Trix-C | Cable System | 220-240 V | topLED 19 W 450 mA



new

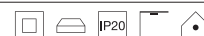

type

White	CRI 80	8429
Grey	CRI 80	8430

colour

3000 K 2050 lm

optics

diffused

Circular-C | Cable System | 220-240 V | topLED 17 W 500 mA

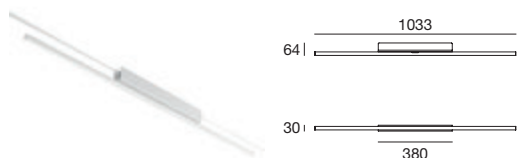

new



type

White	CRI 80	8445
Grey	CRI 80	8446

colour

3000 K 2191 lm

optics

diffused

Oh!-C | Cable System | 220-240 V | topLED 6 W 350 mA

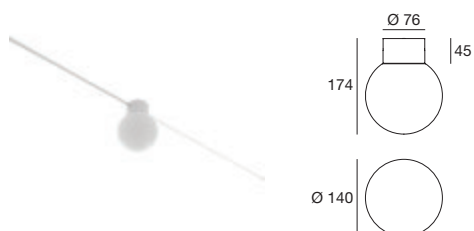

new

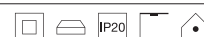

type

White	CRI 80	10115
Grey	CRI 80	10116

colour

3000 K 727 lm

optics

diffused

Orient-C_1 | Cable System | 220-240 V | topLED 30 W 700 mA

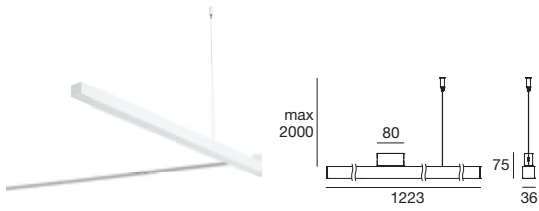

type

White	CRI 80	64244
Grey	CRI 80	64245

colour

3000 K	3569 lm	W
4000 K	3780 lm	N

optics

diffused **00**

Orient-C_2 | Cable System | 220-240 V | 1xG5

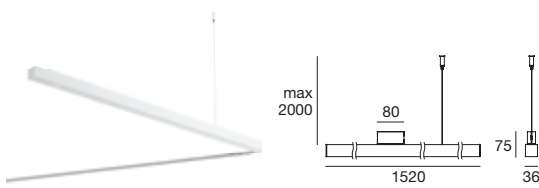

type

White	59734
Grey	59735

source

1x54W

optics

diffused

Orion-C_1 | Cable System | 220-240 V | 2xG9

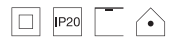

type

White	59754
-------	--------------

source

2x33 W

optics

diffused

Orion-C_2 | Cable System | 220-240 V | 1xGU10



type

White	59744
Grey	59745

source

1x42 W

optics

variable

Point-C | Cable System | 220-240 V | 1xG53

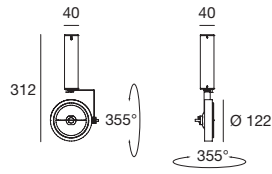

type

White	59538
Grey	59539

source

1x12 W

optics

variable

Andromeda-C_1 | Cable System | 220-240 V | 1xGU10

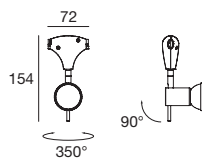

type

Chrome	TR4304-3
Nickel	TR4304-48
Rust	TR4304-9

source

1x42 W

optics

variable

Andromeda-C_2 | Cable System | 220-240 V | 1xE27

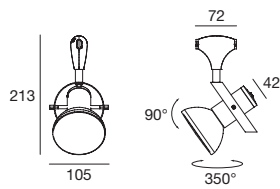

type

Chrome	TR4303-3
Nickel	TR4303-48
Rust	TR4303-9

source

1x77 W

optics

variable

Tek-C_1 | Cable System | 220-240 V | 2xG9

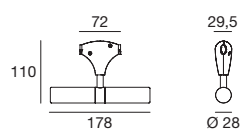

type

Chrome	TR4302-3
Nickel	TR4302-48
Rust	TR4302-9

source

2x33 W

optics

diffused

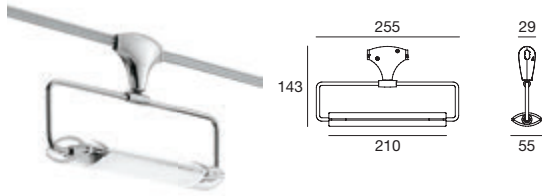
Tek-C_2 | Cable System | 220-240 V | 1xR7s (114,2 mm)**type**

Chrome	TR4307-3
Nickel	TR4307-48
Rust	TR4307-9

source

1x150 W

optics

diffused

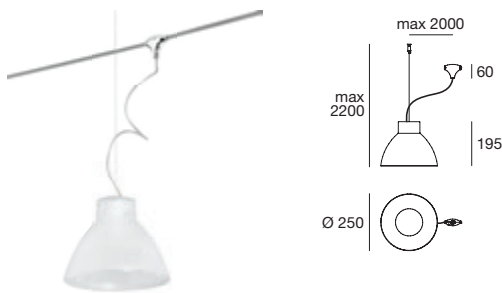
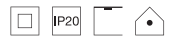
Virgo-C | Cable System | 220-240 V | 1xE27**type**

Chrome	TR4310-3
Nickel	TR4310-48

source

1x20 W

optics

diffused

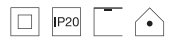
Bell-C | Cable System | 220-240 V | 1xE27**type**

Rust	TR4317-9
------	----------

source

1x20 W

optics

diffused

fastening kit + ceiling rose

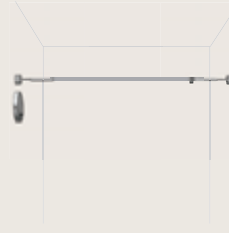

type

White	TR4111-4
Grey	TR4111-5
Rust	TR4111-9
Chrome	TR4111-3
Nickel	TR4111-8

Fastening kit with power supply box.

fastening kit

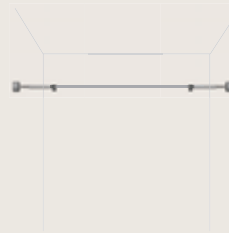

type

White	TR4112-4
Grey	TR4112-5
Rust	TR4112-9
Chrome	TR4112-3
Nickel	TR4112-8

Fastening kit.

R ceiling rose, one conductor

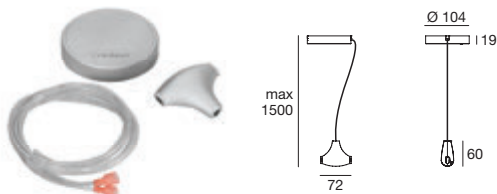

type L mm

Rust	1500	TR4118-9
Chrome	1500	TR4118-3
Nickel	1500	TR4118-48

Ceiling power supply kit, maximum length 150 cm (for one conductor cable).

R ceiling rose, two conductors

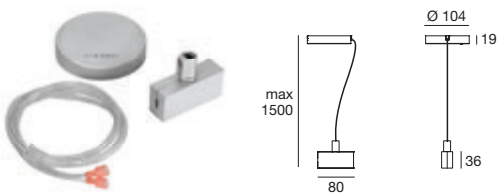

type L mm

White	1500	53234
Grey	1500	53235

Ceiling power supply kit, maximum length 150 cm (for two conductors cable).

connector



type

White	53034
Grey	53035
Chrome	53033
Nickel	53038

Connector to power suspensions of class II, through R4151/TR4152 cable.

couple of connectors



type L mm

Chrome	n.a.	TR4123-3
Nickel	n.a.	TR4123-48

Couple of connectors to power more lines.

spacer

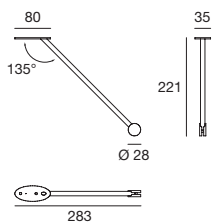

type

White	TR4114-4
Grey	TR4114-5
Rust	TR4114-9
Chrome	TR4114-3
Nickel	TR4114-8

Linear spacer, height 20 cm (fastening and power supply kit excluded).

wall switch kit



type

Chrome	TR4120-3
Nickel	TR4120-8

Wall switch kit.

ceiling switch kit

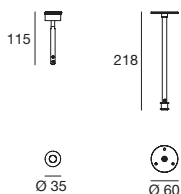

type L mm

Chrome	1500	TR4117-3
Nickel	1500	TR4117-8
Rust	1500	TR4117-9

Ceiling switch kit, height 20 cm.

kit sostegno

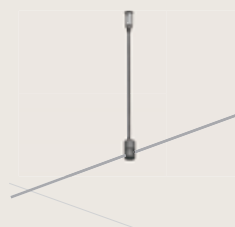

type L mm

White	2000	TR4119-4
Grey	2000	TR4119-5
Rust	2000	TR4119-9
Chrome	2000	TR4119-3
Nickel	2000	TR4119-48

Support kit for line H max 200 cm.

supporting cable



L mm

1000	TR4151
5000	TR4151-5
10000	TR4151-10
15000	TR4151-15
20000	TR4151-20
25000	TR4151-25
30000	TR4151-30
50000	TR4151-50

Supporting cable and two conductors, section 2 x 1,5 mm².

copper supporting cable

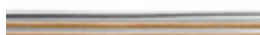

L mm

1000	TR4152
5000	TR4152-5
10000	TR4152-10
15000	TR4152-15
20000	TR4152-20
25000	TR4152-25
30000	TR4152-30
50000	TR4152-50

Supporting cable and two copper conductors, section 2 x 1,5 mm².



150 SYSTEM /



^ SELF-C15 CABLE SYSTEM
< TABLET-C15 CABLE SYSTEM



ORION-C15 CABLE SYSTEM



BELL-C15 CABLE SYSTEM

150 System | Two parallel tension wires, placed between two walls, 150 mm apart from each other, provide support and power to the lighting fixtures: they form an installation level from which both accent and ambient lighting can be created to meet any need, also using different light sources.

Tablet-C15 | Cable System | 220-240 V | topLED 20 W 700 mA

new

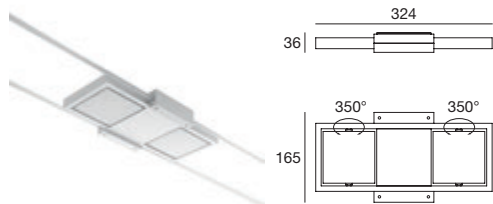

type

White	CRI 80	8435
Grey	CRI 80	8436

colour

3000 K 1877 lm

optics

diffused

Self-C15_RJ | Cable System | 220-240 V | arrayLED 10 W

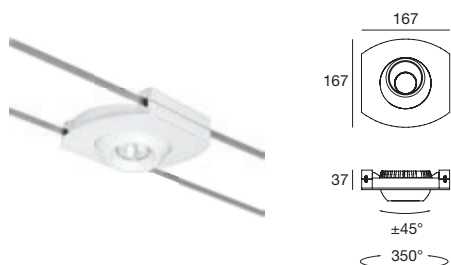

type

White	CRI 80	64732
Grey	CRI 80	64710

colour

3000 K 777 lm

optics

50°

Self-C15_R | Cable System | 220-240 V | topLED 14 W

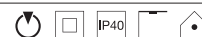

type

White	CRI 80	64731
Grey	CRI 80	64709

colour

3000 K 1313 lm

optics

diffused

Matrix-C15 | Cable System | 220-240 V | 2xG5

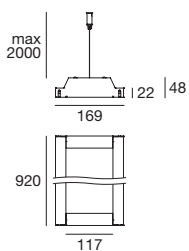

type

- White **59134**
- Grey **59135**

source

2x39 W

optics

diffused

Orion-C15_Q | Cable System | 220-240 V | 1xR7s (74,9 mm)

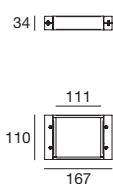

type

- Grey **51635**

source

1x80 W

optics

diffused

Orion-C15_J | Cable System | 220-240 V | 1xE27

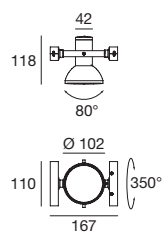

type

- White **59114**
- Grey **59115**

source

1x77 W

optics

variable

Orion-C15_R | Cable System | 220-240 V | 1xE27

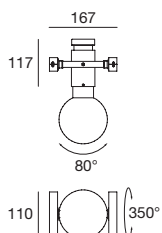

type

- Grey **51755**

source

1x20 W

optics

diffused

Accessories



51745-TR
Diffuser

Point-C15 | Cable System | 220-240 V | 1xG53

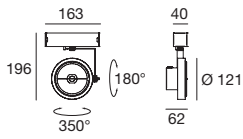

type

White	59532
Grey	59533

source

1x12 W Max

optics

variable

Halley-C15_1 | Cable System | 220-240 V | 1xR7s (74,9 mm)

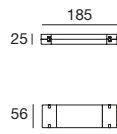
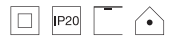

type

Chrome	TR4200-3
Nickel	TR4200-48

source

1x80 W

optics

diffused

Halley-C15_2 | Cable System | 220-240 V | 1xE27

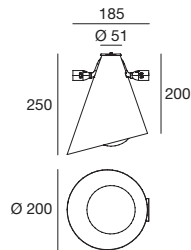

type

Chrome	59223
Nickel	59228
Rust	59229

source

1x20 W

optics

diffused

Halley-C15_J1 | Cable System | 220-240 V | 1xGU10

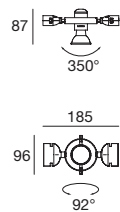

type

Chrome	TR4201-3
Nickel	TR4201-48

source

1x50 W

optics

variable

Halley-C15_J2 | Cable System | 220-240 V | 1xE27

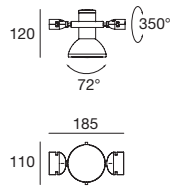
**type**Chrome **TR4202-3**Nickel **TR4202-48****source**

1x77 W

optics

diffused

Bell-C15 | Cable System | 220-240 V | 1xE27

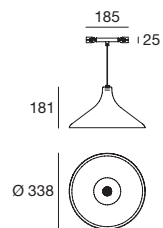
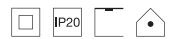
**type**Rust **TR4217-9****source**

1x20 W

optics

diffused

fastening kit

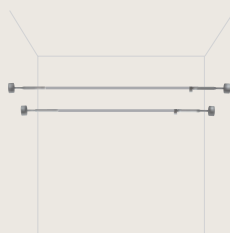
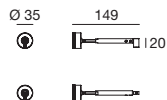

type

White	TR4110-4
Grey	TR4110-5
Rust	TR4110-9
Chrome	TR4110-3
Nickel	TR4110-8

Fastening kit.

fastening kit + ceiling rose

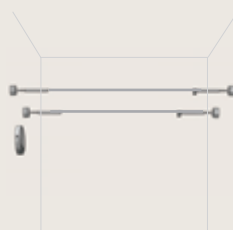
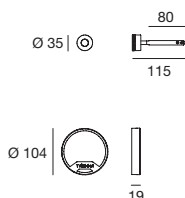

type

White	TR4109-4
Grey	TR4109-5
Rust	TR4109-9
Chrome	TR4109-3
Nickel	TR4109-8

Fastening kit with power supply box.

R ceiling rose, one conductor

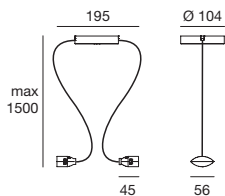

type L mm

Rust	1500	TR4115-9
Chrome	1500	TR4115-3
Nickel	1500	TR4115-48

Ceiling power supply kit, maximum length 150 cm (for one conductor cable).

R ceiling rose, two conductors

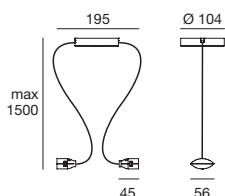

type L mm

Rust	1500	TR4116-9
Chrome	1500	TR4116-3
Nickel	1500	TR4116-48

Ceiling power supply kit, maximum length 150 cm (for two conductors cable).

Q ceiling rose, one conductor

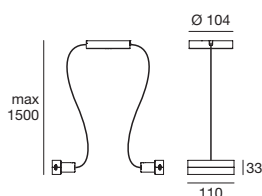

type L mm

White	1500	53204
Grey	1500	53205

Ceiling power supply kit, maximum length 150 cm (for two conductor cable).

Q ceiling rose, two conductors

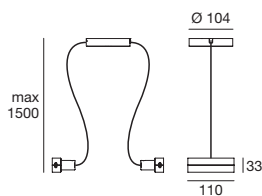

type L mm

White	1500	53214
Grey	1500	53215

Ceiling power supply kit, maximum length 150 cm (for two conductors cable).

couple of R connectors

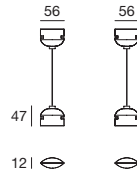

type

Chrome	TR4122-3
Nickel	TR4122-48

Couple of connectors to power more lines.

couple of Q connectors

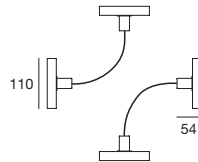

type L mm

Grey	n.a.	53225
------	------	-------

Couple of connectors to power more lines.

spacer

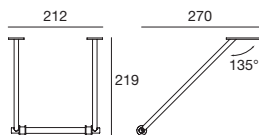

type

White	TR4113-4
Grey	TR4113-5
Rust	TR4113-9
Chrome	TR4113-3
Nickel	TR4113-8

Linear spacer, height 20 cm (fastening and power supply kit excluded).

ceiling switch kit

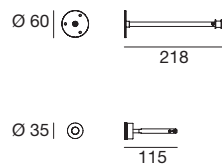

type L mm

Grey	1500	TR4121-5
Rust	1500	TR4121-9
Chrome	1500	TR4121-3
Nickel	1500	TR4121-8

Ceiling switch kit, height 20 cm.

ceiling-wall switch kit

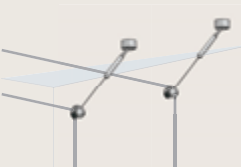
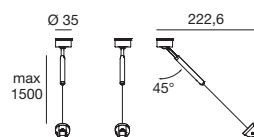

type

Chrome	TR4124-3
Nickel	TR4124-8

Ceiling-wall switch kit.

wall switch kit



type

Chrome	TR4104-3
Nickel	TR4104-8

Wall switch kit

support kit

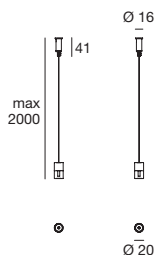

type L mm

White	2000	TR4103-4
Grey	2000	TR4103-5
Rust	2000	TR4103-9
Chrome	2000	TR4103-3
Nickel	2000	TR4103-48

Support kit for line
H max 200 cm.

supporting cable, one conductor



L mm

1000	TR4150
5000	TR4150-5
10000	TR4150-10
15000	TR4150-15
20000	TR4150-20
25000	TR4150-25
30000	TR4150-30
50000	TR4150-50

Supporting cable and one
conductor, section 1 x 1,5 mm².

supporting cable



L mm

1000	TR4151
5000	TR4151-5
10000	TR4151-10
15000	TR4151-15
20000	TR4151-20
25000	TR4151-25
30000	TR4151-30
50000	TR4151-50

Supporting cable and two
conductors, section 2 x 1,5 mm².

copper supporting cable



L mm

1000	TR4152
5000	TR4152-5
10000	TR4152-10
15000	TR4152-15
20000	TR4152-20
25000	TR4152-25
30000	TR4152-30
50000	TR4152-50

Supporting cable and two copper
conductors, section 2 x 1,5 mm².



upgraded

Home Lighting 1.0_indoor

300 SYSTEM /



^ VEGA-C30 CABLE SYSTEM
< BEEBO-C30 CABLE SYSTEM

TRIX-C30 CABLE SYSTEM





TRIX-C30 CABLE SYSTEM

300 System | Two parallel tension wires, placed between two walls, 300 mm apart from each other, provide support and power to the lighting fixtures: they form an installation level from which both accent and ambient lighting can be created to meet any need, also using different light sources.

Trix-C30_1 | Cable System | 220-240 V | topLED 19 W 450 mA

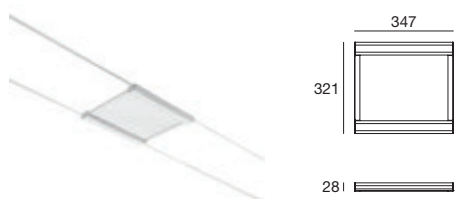

new



type

White	CRI 80	8425
Grey	CRI 80	8426

colour

3000 K 2050 lm

optics

diffused

Trix-C30_2 | Cable System | 220-240 V | topLED 28 W 350 mA

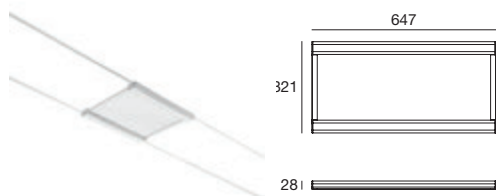

new



type

White	CRI 80	8427
Grey	CRI 80	8428

colour

3000 K 3259 lm

optics

diffused

Tablet-C30 | Cable System | 220-240 V | topLED 20 W 700 mA

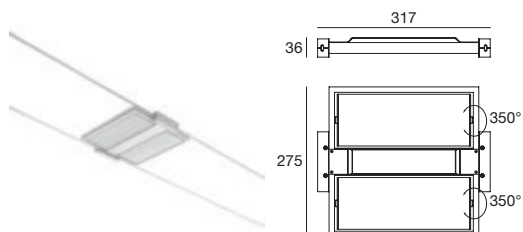

new



type

White	CRI 80	8437
Grey	CRI 80	8438

colour

3000 K 2914 lm

optics

diffused

Beebo-C30 | Cable System | 220-240 V | topLED 18 W 1000 mA

new

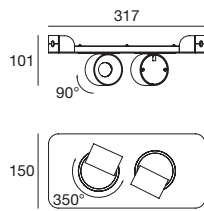
**type**

White	CRI 80	8442
Grey	CRI 80	8443

colour

3000 K 2324 lm

optics

diffused

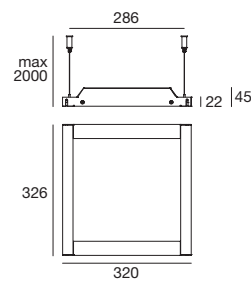
Matrix-C30_1 | Cable System | 220-240 V | 2x2G10**type**

White	51254
Grey	51255

source

2x36 W

optics

diffused

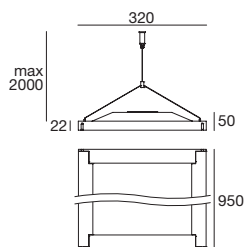
Matrix-C30_2 | Cable System | 220-240 V | topLED 52 W 650 mA**type**

White	CRI 80	54284
Grey	CRI 80	54285

colour

4000 K 5590 lm

optics

diffused

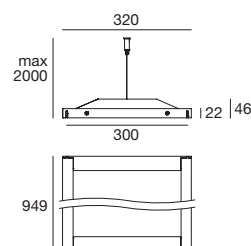
Matrix-C30_3 | Cable System | 220-240 V | 2xG5**type**

White	51234
Grey	51235

source

2x39W

optics

diffused

Matrix-C30_4 | Cable System | 220-240 V | 2xG5

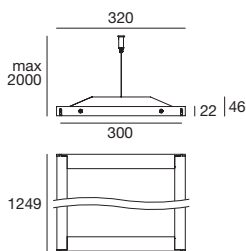

type

- White **51244**
- Grey **51245**

source

2x54 W

optics

diffused

Orion-C30 | Cable System | 220-240 V | 1xR7s (114,2mm)

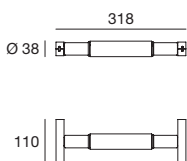
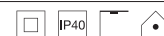

type

- Grey **51535**

source

1x200 W Max

optics

diffused

Orion-C30J | Cable System | 220-240 V | 1xE27

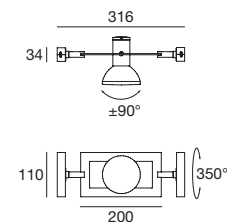

type

- Grey **51545**

source

1x100 W Max

optics

variable

Point-C30 | Cable System | 220-240 V | 2xG53

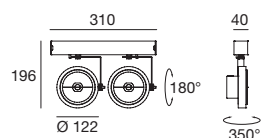

type

- White **59530**
- Grey **59531**

source

2x12 W Max

optics

variable

Vega-C30_1 | Cable System | 220-240 V | 1xR7s (114,2mm)

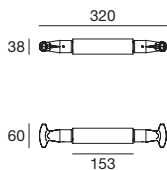

type

- Grey **TR4000-5**
- Rust **TR4000-9**
- Chrome **TR4000-3**

source

1x200 W Max

optics

diffused

Vega-C30_2 | Cable System | 220-240 V | 1xE27

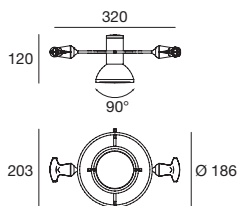

type

- Grey **TR4014-5**
- Chrome **TR4014-3**

source

1x100 W Max

optics

variable

Vega-C30_3 | Cable System | 220-240 V | 1xE27

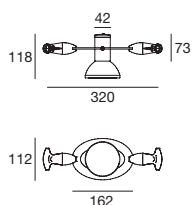

type

- Rust **51456**

source

1x75 W Max

optics

variable

Modular-C30_4 | Cable System | 220-240 V | 2xG5

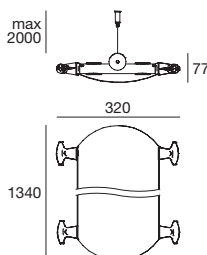
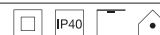

type

- Grey **TR4008-5**

source

2x54 W Max

optics

diffused

fastening kit Ø 35

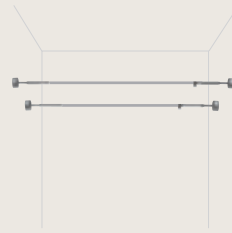
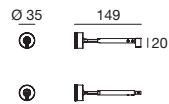

type

White	TR4110-4
Grey	TR4110-5
Rust	TR4110-9
Chrome	TR4110-3
Nickel	TR4110-8

Fastening kit (Ø 35).

fastening kit Ø 50

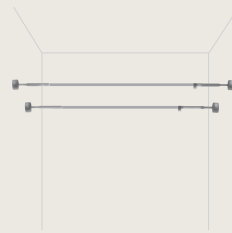
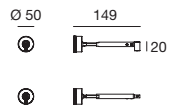

type

Grey	TR4108-5
Chrome	TR4108-3
Nickel	TR4108-8

Fastening kit (Ø 50).

fastening kit + ceiling rose Ø 35

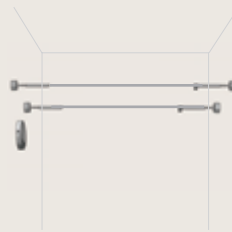
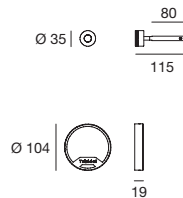

type

White	TR4109-4
Grey	TR4109-5
Rust	TR4109-9
Chrome	TR4109-3
Nickel	TR4109-8

Fastening kit with power supply box (Ø 35).

fastening kit + ceiling rose Ø 50

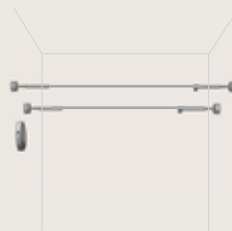
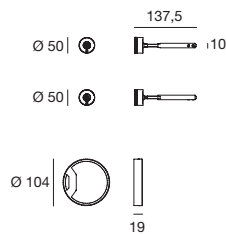

type

Grey	TR4100-5
Chrome	TR4100-3
Nickel	TR4100-8

Fastening kit with power supply box (Ø 50).

R ceiling rose, one conductor

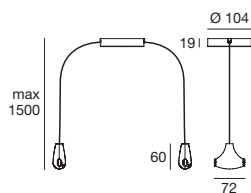

type L mm

Grey	1500	TR4102-5
Rust	1500	TR4102-9
Chrome	1500	TR4102-3
Nickel	1500	TR4102-48

Ceiling power supply kit, maximum length 150 cm (for one conductor cable).

R ceiling rose, two conductors

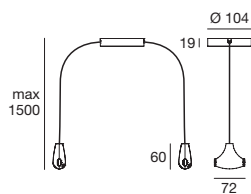

type L mm

Grey	1500	TR4107-5
Rust	1500	TR4107-9
Chrome	1500	TR4107-3
Nickel	1500	TR4107-48

Ceiling power supply kit, maximum length 150 cm (for two conductors cable).

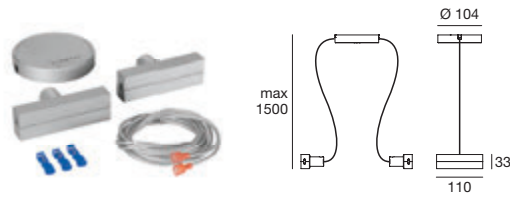
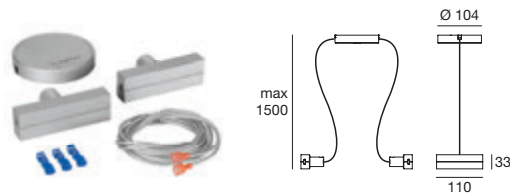
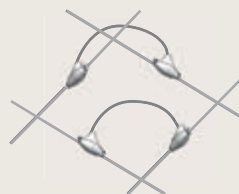
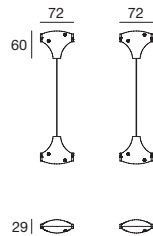
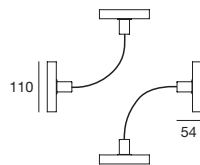
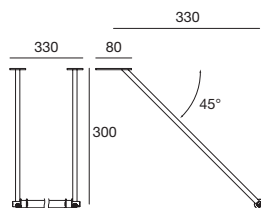
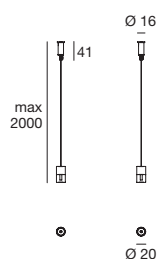
Q ceiling rose, one conductor**type** **L mm**White 1500 **53204**Grey 1500 **53205**Ceiling power supply kit,
maximum length 150 cm
(for one conductor cable).**Q ceiling rose, two conductors****type** **L mm**White 1500 **53214**Grey 1500 **53215**Ceiling power supply kit,
maximum length 150 cm
(for two conductors cable).**couple of R connectors****type**Chrome **TR4106-3**Nickel **TR4106-48**Grey **TR4106-5**Couple of connectors to
power more lines.**couple of Q connectors****type**Grey **53225**Couple of connectors to
power more lines.**spacer****type**White **TR4101-4**Grey **TR4101-5**Rust **TR4101-9**Chrome **TR4101-3**Nickel **TR4101-48**Linear spacer, height 30 cm
(fastening and power supply
kit excluded).**support kit****type** **L mm**White 2000 **TR4103-4**Grey 2000 **TR4103-5**Rust 2000 **TR4103-9**Chrome 2000 **TR4103-3**Nickel 2000 **TR4103-48**Support kit for line
H max 200 cm.

ceiling switch kit

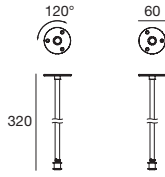

type L mm

Grey	1500	TR4105-5
Chrome	1500	TR4105-3
Nickel	1500	TR4105-8

Ceiling switch kit, height 30 cm.

ceiling-wall switch kit

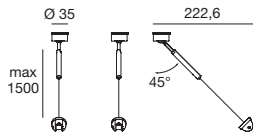

type

Chrome	TR4124-3
Nickel	TR4124-8

Ceiling-wall switch kit.

wall switch kit



type

Chrome	TR4104-3
Nickel	TR4104-8

Wall switch kit.

supporting cable, one conductor



L mm

1000	TR4150
5000	TR4150-5
10000	TR4150-10
15000	TR4150-15
20000	TR4150-20
25000	TR4150-25
30000	TR4150-30
50000	TR4150-50

Supporting cable and one conductor, section 1 x 1,5 mm².

supporting cable



L mm

1000	TR4151
5000	TR4151-5
10000	TR4151-10
15000	TR4151-15
20000	TR4151-20
25000	TR4151-25
30000	TR4151-30
50000	TR4151-50

Supporting cable and two conductors, section 2 x 1,5 mm².

copper supporting cable



L mm

1000	TR4152
5000	TR4152-5
10000	TR4152-10
15000	TR4152-15
20000	TR4152-20
25000	TR4152-25
30000	TR4152-30
50000	TR4152-50

Supporting cable and two copper conductors, section 2 x 1,5 mm².



MYWHITE /



^ MINIWHITE WALL LIGHTS
< MYWHITE CEILING LIGHTS

MYWHITE WALL LIGHTS





MYWHITE WALL LIGHTS



MyWhite | A family of wall lights and ceiling light fixtures designed for exterior spaces but also suitable for interiors characterized by an essential and clean design. They are perfect to create evocative compositions that can enhance any environment.

Materials: white linear polyethylene casing for diffused lighting; white linear polyethylene base.

MyWhite_U | Ceiling_Wall Lights | 220-240 V | topLED 11 W 350 mA

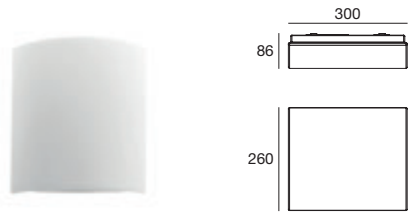

type		colour		optics
White	CRI85 7889	3000 K	1246 lm	Diffused

MyWhite_U | Ceiling_Wall Lights | 220-240 V | topLED 17 W 350 mA

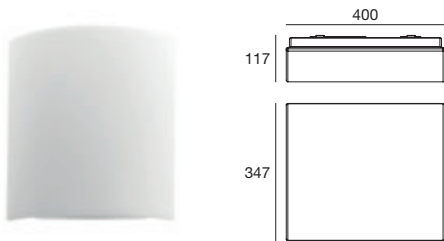

type		colour		optics
White	CRI85 7890	3000 K	1800 lm	Diffused

MyWhite_O | Ceiling_Wall Lights | 220-240 V | topLED 8 W 350 mA



type		colour		optics
White	CRI85 8027	3000 K	970 lm	Diffused
White	CRI85 8027N	4000 K	1108 lm	Diffused

MiniWhite_R | Ceiling_Wall Lights | 220-240 V | topLED 4 W 250 mA

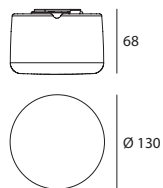

type	colour	optics
White CRI85 8028	3000 K 400 lm	Diffused
White CRI85 8028N	4000 K 462 lm	Diffused

MyWhite_R | Ceiling_Wall Lights | 220-240 V | topLED 10 W 500 mA

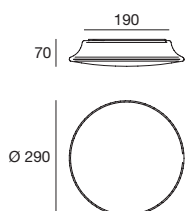
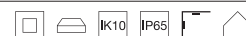

type	colour	optics
White CRI85 7805	3000 K 1340 lm	Diffused
White CRI85 7805N	4000 K 1530 lm	Diffused

MyWhite_R | Ceiling_Wall Lights | 220-240 V | topLED 16 W 350 mA

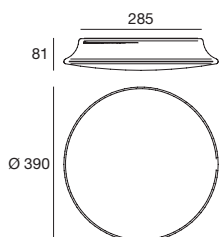
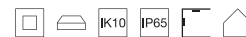

type	colour	optics
White CRI85 7806	3000 K 1662 lm	Diffused
White CRI85 7806N	4000 K 1898 lm	Diffused

MyWhite_R | Ceiling_Wall Lights | 220-240 V | topLED 16 W 350 mA

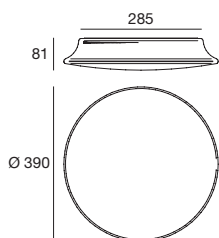

type	colour	optics
White CRI85 7806S	3000 K 1662 lm	Diffused
White CRI85 7806NS	4000 K 1898 lm	Diffused



motion sensor



time 3 min.



sensitivity range Ø 5 m. H 2,7 m.

MyWhite_R | Ceiling_Wall Lights | 220-240 V | topLED 16 W 350 mA

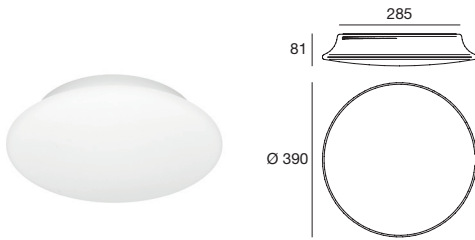
**type**

White	CRI85	7806E
-------	-------	--------------

colour

3000 K	1662 lm
--------	---------

optics

Diffused

White	CRI85	7806NE
-------	-------	---------------

4000 K	1898 lm
--------	---------

Diffused



emergency

EM autonomy
3 h.EM brightness
14%

MiniWhite_Q | Ceiling_Wall Lights | 220-240 V | topLED 4 W 250 mA

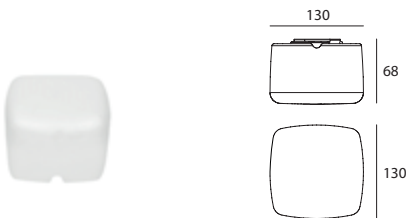
**type**

White	CRI85	8029
-------	-------	-------------

colour

3000 K	400 lm
--------	--------

optics

Diffused

White	CRI85	8029N
-------	-------	--------------

4000 K	462 lm
--------	--------

Diffused

MyWhite_Q | Ceiling_Wall Lights | 220-240 V | topLED 10 W 500 mA

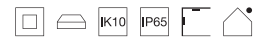
**type**

White	CRI85	7807
-------	-------	-------------

colour

3000 K	1340 lm
--------	---------

optics

Diffused

White	CRI85	7807N
-------	-------	--------------

4000 K	1530 lm
--------	---------

Diffused

MyWhite_Q | Ceiling_Wall Lights | 220-240 V | topLED 16 W 350 mA

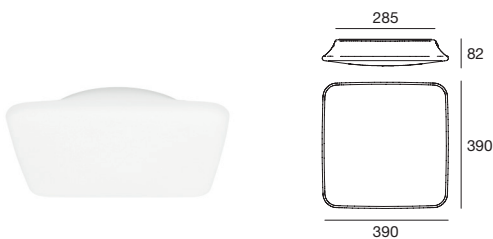
**type**

White	CRI85	7808
-------	-------	-------------

colour

3000 K	1662 lm
--------	---------

optics

Diffused

White	CRI85	7808N
-------	-------	--------------

4000 K	1898 lm
--------	---------

Diffused

MyWhite_Q | Ceiling_Wall Lights | 220-240 V | topLED 16 W 350 mA

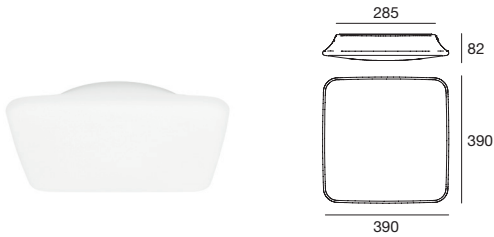

type	colour	optics
White CRI85 7808S	3000 K 1662 lm	Diffused
White CRI85 7808NS	4000 K 1898 lm	Diffused

motion sensor	time 3 min.	sensitivity range Ø 5 m. H 2,7 m.

MyWhite_Q | Ceiling_Wall Lights | 220-240 V | topLED 16 W 350 mA

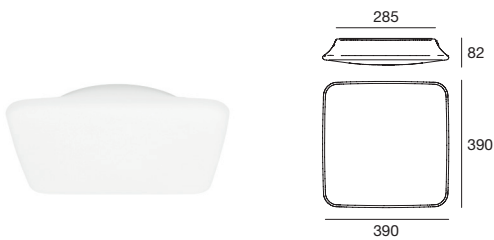

type	colour	optics
White CRI85 7808E	3000 K 1662 lm	Diffused
White CRI85 7808NE	4000 K 1898 lm	Diffused

emergency	EM autonomy 3 h.	EM brightness 14%

MyWhite_B | Ceiling_Wall Lights | 220-240 V | topLED 11 W 350 mA

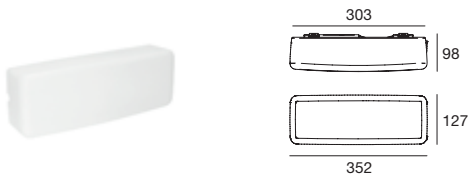

type	colour	optics
White CRI85 7809	3000 K 1108 lm	Diffused
White CRI85 7809N	4000 K 1265 lm	Diffused

MyWhite_B | Ceiling_Wall Lights | 220-240 V | topLED 17 W 350 mA

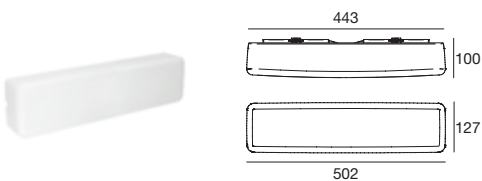

type	colour	optics
White CRI85 7810	3000 K 1801 lm	Diffused
White CRI85 7810N	4000 K 2057 lm	Diffused

MyWhite_B | Ceiling_Wall Lights | 220-240 V | topLED 17 W

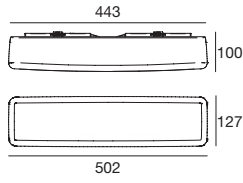

type	colour	optics
White CRI85 7810S	3000 K 1801 lm	Diffused
White CRI85 7810NS	4000 K 2057 lm	Diffused



motion sensor



time **3 min.**



sensitivity range
Ø 5 m. H 2,7 m.

MyWhite_B | Ceiling_Wall Lights | 220-240 V | topLED 17 W

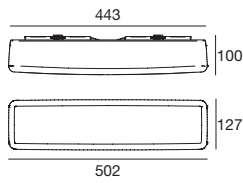

type	colour	optics
White CRI85 7810E	3000 K 1801 lm	Diffused
White CRI85 7810NE	4000 K 2057 lm	Diffused



emergency



EM autonomy
3 h.



EM brightness
7%



PLAF /



^ PLAF CEILING LIGHTS
< PLAF WALL LIGHTS

Plaf | A wall and ceiling light that welcomes and greets one at the door or in a porch, with the kindness and discretion of a true hostess.

Materials: white coated plastic mounting frame; white silk-screened glass diffuser.

Plaf | Ceiling_Wall Lights | 220-240 V | 1xE27



type

White 7151

source

1x46 W Max

optics

diffused

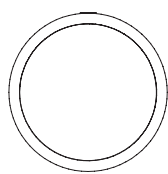

Ø 250

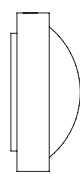

110



OH!_OUT /



OH! PENDANT LUMINAIRES



OH! FLOOR LAMPS



OH! MARS FLOOR LAMPS



OH! FLOOR LAMPS



OHI FLOOR LAMPS

Oh!_OUT | The perfection of the sphere, the naturalness of light, a pleasant presence in every space: alone or in company, a suspension light that knows how to decorate and illuminate with simplicity and spontaneity.

Materials: white linear polyethylene casing for diffused lighting; white linear polyethylene base.

Oh!_P65 | Pendant Luminaires | 220-240 V

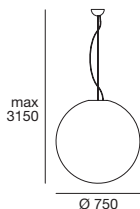
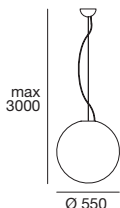
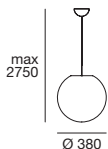
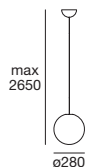
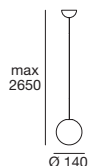

new



topLED 6 W 350 mA

White CRI 90 15111

colour

3000 K 726 lm

optics

diffused

KIT0066 ON-OFF Driver 1-2 art.

new



topLED 8 W 350 mA

White CRI 90 15113

colour

3000 K 1002 lm

optics

diffused

KIT0066 ON-OFF Driver 1 art.



1xE27

White 15180

source

1x46 W Max

optics

diffused



topLED 15 W 350 mA

White CRI 90 15106

colour

3000 K 1893 lm

optics

diffused



1xE27

White 15168

source

1x46 W Max

optics

diffused



topLED 20 W 500 mA

White CRI 90 15110

colour

3000 K 2652 lm

optics

diffused



1xE27

White 15169

source

1x46 W Max

optics

diffused

new



topLED 29 W 700 mA

White CRI 93 15115

colour

3000 K 3674 lm

optics

diffused



1xE27

White 15170

source

1x57 W Max

optics

diffused

Oh!_S65 | Ceiling Lights | 220-240 V



new



topLED 8 W 350 mA

White CRI 93 **15112**

colour
3000 K 1002 lm

optics
diffused

KIT0066 ON-OFF Driver 1 art.



1xE27

White **15181**

source
1x30 W Max

optics
diffused

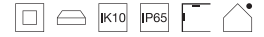

topLED 15 W 350 mA

White CRI 93 **15105**

colour
3000 K 1893 lm

optics
diffused



1xE27

White **15183**

source
1x46 W Max

optics
diffused

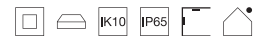

topLED 20 W 500 mA

White CRI 93 **15109**

colour
3000 K 2652 lm

optics
diffused



1xE27

White **15185**

source
1x46 W Max

optics
diffused

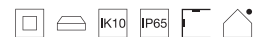

new

topLED 29 W 700 mA

White CRI 93 **15114**

colour
3000 K 3674 lm

optics
diffused



1xE27

White **15187**

source
1x57 W Max

optics
diffused



1xE27

White **15189**

source
1x57 W Max

optics
diffused

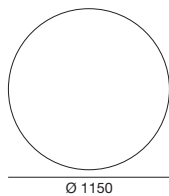
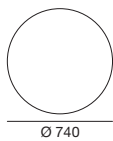
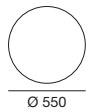



6 W 500 mA

colour

optics

White 15156

RGB

diffused

electronics

accessories



99140

RGB system

14930

Outer casing

14931

Pegs



6 W 500 mA

colour

optics

White 15161

RGB

diffused

electronics

accessories



99140

RGB system

14930

Outer casing

14931

Pegs

14080

Anti-theft



12 W 500 mA

colour

optics

White 15163

RGB

diffused

electronics

accessories



99140

RGB system

14930

Outer casing

14931

Pegs

14081

Anti-theft

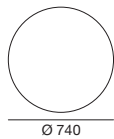

18 W 500 mA

colour

optics

White 15165

RGB

diffused

electronics

accessories



99140

RGB system

14930

Outer casing

14931

Pegs

14082

Anti-theft

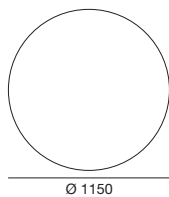

24 W 500 mA

colour

optics

White 15167

RGB

diffused

electronics

accessories



99140

RGB system

14930

Outer casing

14931

Pegs

14083

Anti-theft

Oh!_FL65 | Floor Lamp | 220-240 V

**topLED 8 W 350 mA****colour****optics**

White CRI 90 **15190**

3000 K 1002 lm

diffused

electronics**accessories**

KIT0066

ON-OFF
Driver
1-3 art.

14930

Outer casing

14931

Pegs

**topLED 15 W 350 mA****colour****optics**

White CRI 90 **15191**

3000 K 1893 lm

diffused

accessories

14992

DMX 2 poles
connectors

14930

Outer casing

14931

Pegs

14080

Anti-theft

**topLED 20 W 500 mA****colour****optics**

White CRI 90 **15192**

3000 K 2652 lm

diffused

accessories

14992

DMX 2 poles
connectors

14930

Outer casing

14931

Pegs

14081

Anti-theft

**topLED 29 W 700 mA****colour****optics**

White CRI 90 **15193**

3000 K 3674 lm

diffused

accessories

14992

DMX 2 poles
connectors

14930

Outer casing

14931

Pegs

14082

Anti-theft

**topLED 29 W 700 mA****colour****optics**

White CRI 90 **15194**

3000 K 3674 lm

diffused

accessories

14992

DMX 2 poles
connectors

14930

Outer casing

14931

Pegs

14083

Anti-theft

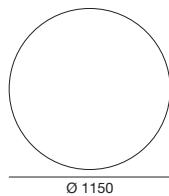

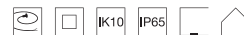

1xE27

White 15150

source

1x30 W Max

optics

diffused

accessories



14992
DMX 2 poles connectors



14930
Outer casing connectors



14931
Pegs

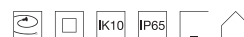

1xE27

White 15160

source

1x46 W Max

optics

diffused

accessories



14992
DMX 2 poles connectors



14930
Outer casing connectors



14931
Pegs



14080
Anti-theft

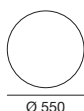
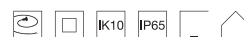

1xE27

White 15162

source

1x46 W Max

optics

diffused

accessories



14992
DMX 2 poles connectors



14930
Outer casing connectors



14931
Pegs



14081
Anti-theft

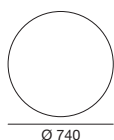
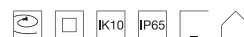

1xE27

White 15164

source

1x57 W Max

optics

diffused

accessories



14992
DMX 2 poles connectors



14930
Outer casing connectors



14931
Pegs



14082
Anti-theft

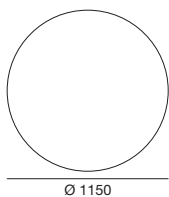
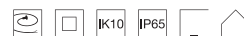

1xE27

White 15166

source

1x77 W Max

optics

diffused

accessories



14992
DMX 2 poles connectors



14930
Outer casing connectors



14931
Pegs



14083
Anti-theft

Oh!_Mars | Floor Lamp | 220-240 V



1xE27
Brown **15130**

source
1x30 W Max

optics
diffused

accessories

14930 **14931**
Outer casing Pegs



1xE27
Brown **15131**

source
1x46 W Max

optics
diffused

accessories

14930 **14931**
Outer casing Pegs

14080
Anti-theft



1xE27
Brown **15132**

source
1x46 W Max

optics
diffused

accessories

14930 **14931**
Outer casing Pegs

14081
Anti-theft

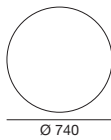

1xE27
Brown **15133**

source
1x57 W Max

optics
diffused

accessories

14930 **14931**
Outer casing Pegs

14082
Anti-theft



OHPS_OUT /



OHPS FLOOR LAMP

Ohps_OUT | The perfection of the half-sphere, the naturalness of light, a pleasant presence in every space: whether alone or in company, a luminaire that knows how to decorate and illuminate with simplicity and spontaneity.

Materials: translucent white linear polyethylene casing for diffused lighting; base made of matt white coated metal and of white linear polyethylene.

Ohps_S65 | Ceiling Lights | 220-240 V | 1xE27

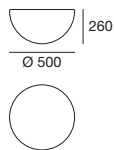

type	colour	optics
White CRI 90 15386	1x30 W Max	diffused

Ohps_S65 | Ceiling Lights | 220-240 V | 1xE27

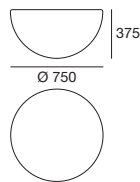
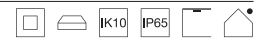

type	source	optics
White CRI 90 15387	1x46 W Max	diffused

Ohps_FL65 | Floor Lamp | 1 x powerLED 6 W 500 mA | RGB

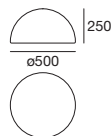

type	colour	optics
White 15381	RGB	diffused

electronics	accessories		
99140 RGB system	14930 Outer casing	14931 Pegs	14100 Anti-theft

Ohps_FL65 | Floor Lamp | 220-240 V | arrayLED 5 W 120 mA

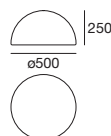
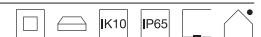

type	colour	optics
White CRI 90 15384	3000 K 528 lm	diffused

accessories			
14992 DMX 2 poles connectors	14930 Outer casing	14931 Pegs	14100 Anti-theft

Ohps_FL65 | Floor Lamp | 220-240 V | 1xE27

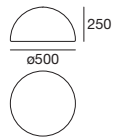
**type**White CRI 90 **15380****colour**

1x30 W Max

optics

diffused

accessories14930
Outer casing14931
Pegs14100
Anti-theft

Ohps_FL | Floor Lamp | 1 x powerLED 12 W 500 mA

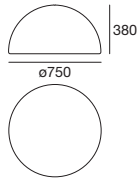
**type**White **15383****colour**

RGB

optics

diffused

electronics99140
RGB system**accessories**14930
Outer casing14931
Pegs14100
Anti-theft

Ohps_FL65 | Floor Lamp | 220-240 V | arrayLED 19 W 500 mA

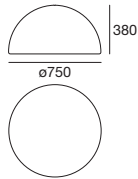
**type**White CRI 90 **15385****colour**

3000 K 2115 lm

optics

diffused

accessories14930
Outer casing14931
Pegs14100
Anti-theft

Ohps_FL65 | Floor Lamp | 220-240 V | 1xE27

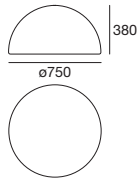
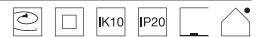
**type**White **15382****source**

1x46 W Max

optics

diffused



OH! SMASH_OUT /



^ OH! SMASH CEILING LIGHTS
< OH! SMASH FLOOR LAMPS

Oh! Smash_OUT | Technologically advanced light globes with round shapes that fill the room with an enveloping, welcoming light.

Materials: base in white wrinkle-effect coated metal or in white polyethylene; polyethylene diffuser.

Oh! Smash_P65 | Pendant Luminaires | 220-240 V | topLED 15 W 350 mA

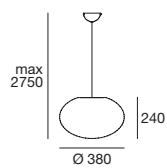

type

White CRI 90 **15224**

colour

3000 K 1893 lm

optics

diffused

Oh! Smash_P65 | Pendant Luminaires | 1xE27

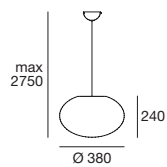

type

White **15213**

source

1x30 W Max

optics

diffused

Oh! Smash_P65 | Pendant Luminaires | 220-240 V | topLED 20 W 500 mA

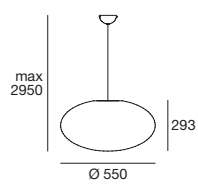

type

White CRI 90 **15226**

colour

3000 K 2652 lm

optics

diffused

Oh! Smash_P65 | Pendant Luminaires | 220-240 V | 1xE27

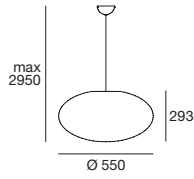

type

White 15216

source

1x46 W Max

optics

diffused

Oh! Smash_S65 | Ceiling Lights | 220-240 V | topLED 15 W 350 mA

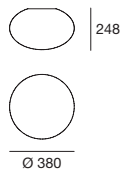
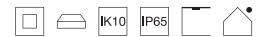

type

White CRI 93 15223

colour

3000 K 1893 lm

optics

diffused

Oh! Smash_S65 | Ceiling Lights | 220-240 V | 1xE27

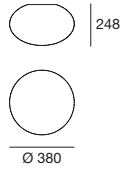
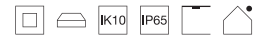

type

White 15214

source

1x30 W Max

optics

diffused

Oh! Smash_S65 | Ceiling Lights | 220-240 V | topLED 20 W 500 mA

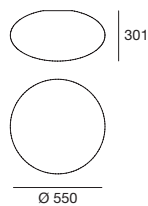
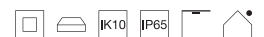

type

White CRI 93 15225

colour

3000 K 2652 lm

optics

diffused

Oh! Smash_S65 | Ceiling Lights | 220-240 V | 1xE27

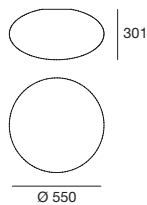

type

White 15217

colour

1x46 W Max

optics

diffused

Oh! Smash_FL65 | Floor Lamp | 220-240 V | topLED 15 W 350 mA

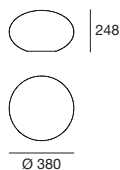

type

White CRI 90 15219

colour

3000 K 1893 lm

optics

diffused

accessories



Oh! Smash_FL65 | Floor Lamp | 220-240 V | 1xE27

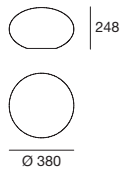

type

White 15215

colour

1x30 W Max

optics

diffused

accessories



Oh! Smash_FL65 | Floor Lamp | 220-240 V | 1 x powerLED 6 W 200 mA

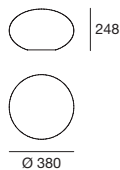

type

White CRI 93 15220

colour

RGB

optics



diffused

accessories



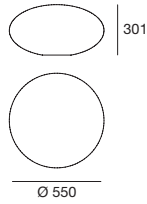



Oh! Smash_FL65 | Floor Lamp | 220-240 V | 1 x powerLED 6 W 200 mA

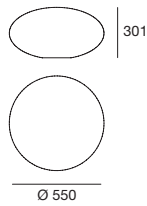

type	colour	optics
White CRI 90 15222	RGB	diffused
electronics	accessories	
 99140 RGB system	 14930 Outer casing	 14931 Pegs



Oh! Smash_FL65 | Floor Lamp | 220-240 V | topLED 20 W 500 mA

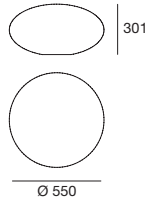

type	colour	optics
White CRI 90 15221	3000 K 2652 lm	diffused
accessories		
 14992 DMX 2 poles connectors	 14930 Outer casing	 14931 Pegs

Oh! Smash_FL65 | Floor Lamp | 220-240 V | 1xE27



type	source	optics
White 15218	1x46 W Max	diffused
accessories		
 14930 Outer casing	 14931 Pegs	



new

OH! SOLAR /

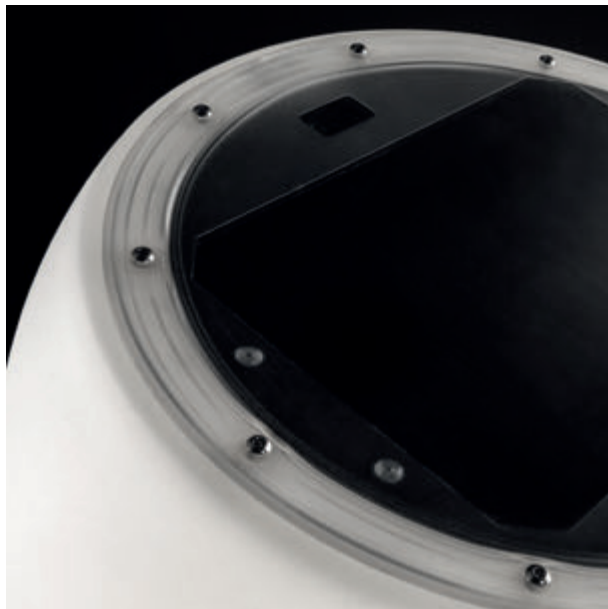

OH! SOLAR FLOOR LAMPS

OH! SOLAR FLOOR LAMPS



Oh! Solar | Light at its best, in this luminous solar recharge outdoor sphere. Playing in the lawn with lighting globes, a piece of sky in house garden.

Materials: natural polythene diffuser, upper structure in polycarbonate.

Oh! Solar | Floor Lamps | Self-sustaining PV | 1 x powerLED 2 W

new



type

White CRI 80 **15120**

colour

3000 K 120 lm

optics

diffused

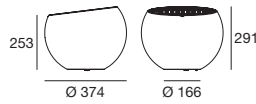



OH!_UW /



OH!_UW SUBMERGED

Oh!_UW | The perfection of the sphere, the naturalness of light, a pleasant presence in every space: alone or in company, a suspension light that knows how to decorate and illuminate with simplicity and spontaneity.

Materials: white linear polyethylene casing for diffused lighting; white linear polyethylene base.

Oh!_UW | Submerged | 1 x powerLEDs 0,5 W

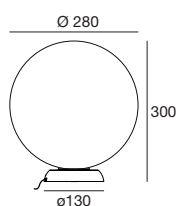

type

White CRI 80 **15158**

colour

RGB

optics

diffused





MARGE /



MARGE FLOOR LAMPS

MARGE FLOOR LAMPS



Marge | The generous and curious shape of an original and entertaining garden light attracts people's gaze and lights up everything around it.

Materials: white linear polyethylene base and casing for diffused lighting.

Marge_FL65 | Floor Lamps | stripLED 36 W 24 V

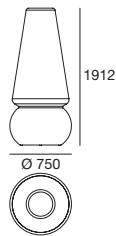

type	colour	optics	
<input type="text" value="White"/> 10000	<input type="text" value="RGB"/>	<input type="text" value="diffused"/>	
electronics	accessories		
99140 RGB system	14937 Pegs	10013 Weight	10015 Anti-theft

Marge_FL65 | Floor Lamps | 220-240 V | 4xE27

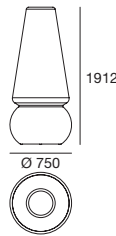

type	source	optics	
<input type="text" value="White"/> 10001	<input type="text" value="4x46 W Max"/>	<input type="text" value="diffused"/>	
accessories			
14937 Pegs	10013 Weight	10015 Anti-theft	14991 Clips 3 poles



PEGGY /



PEGGY FLOOR LAMPS

Peggy | A small sail captures the air, transforming it into light: a garden light that surprises with its presence, a tapered silhouette makes it the queen of every garden.

Materials: white linear polyethylene casing for diffused lighting; white linear polyethylene base.

Peggy_FL | Floor Lamps | 220-240 V | topLED 7 W 600 mA

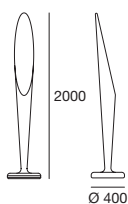
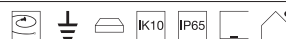

type	colour	optics
White CRI 80 15200	3000 K 381 lm	diffused

accessories

14937 Pegs	14020 Anti-theft	10013 Weight
----------------------	----------------------------	------------------------

Peggy_FL | Floor Lamps | 220-240 V | 1xGU10

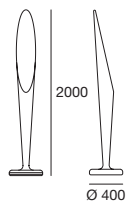
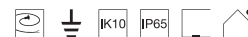

type	source	optics
White 15201	Halogen 1x42 W (included)	diffused

accessories

14937 Pegs	10013 Weight	14020 Anti-theft	14991 Clips 3 poles
----------------------	------------------------	----------------------------	-------------------------------

Peggy_FL | Floor Lamp | 220-240 V | 1xE27

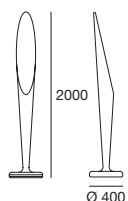
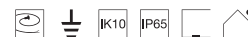

type	source	optics
White 15202	1x20 W Max	diffused

accessories

14937 Pegs	10013 Weight	14020 Anti-theft	14991 Clips 3 poles
----------------------	------------------------	----------------------------	-------------------------------



FLOWER /



FLOWER FLOOR LAMPS

FLOWER FLOOR LAMPS



Flower | Colour, joy and light make up this vase that serves as a veritable outdoor furnishing element, to enjoy your garden and the outdoors to the full.

Materials: white linear polyethylene casing for diffused lighting; white linear polyethylene base.

Flower_FL table | Floor Lamps | 220-240 V | 1 x powerLED 18 W 500 mA

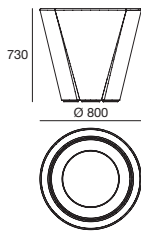

type

White **15050**

source

RGB

optics

diffused

electronics



99140
RGB system

accessories



14930
Outer casing



14937
Pegs



14040
Weight



14041
Anti-theft

Flower_FL table | Floor Lamps | 220-240 V | 1x E27

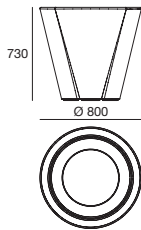
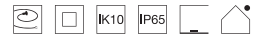

type

White **15051**

source

1x57 W max

optics

diffused

accessories



14992
DMX 2 poles connectors



14930
Outer casing



14937
Pegs



14040
Weight



14041
Anti-theft

Flower_FL seat | Floor Lamps | 220-240 V | 1 x powerLED 6 W 500 mA

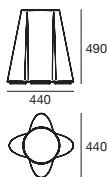

type

White **15058**

source

RGB

optics

diffused

electronics



99140
RGB system

accessories



14930
Outer casing



14937
Pegs



14040
Weight



14041
Anti-theft

Flower_FL seat | Floor Lamps | 220-240 V | 1xE27

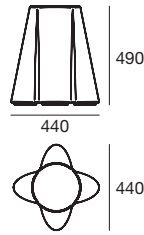

type
White 15059

source
1x30 W max

optics
diffused

accessories

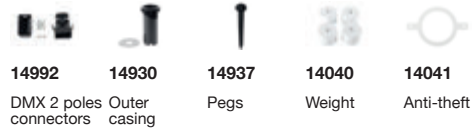

Flower_FL pot | Floor Lamps | 220-240 V | 1 x powerLED 6 W 500 mA

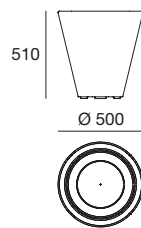

type
White 15054

source
RGB

optics
diffused

electronics accessories

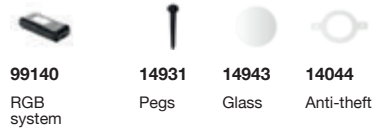

Flower_FL pot | Floor Lamps | 220-240 V | 1xE27

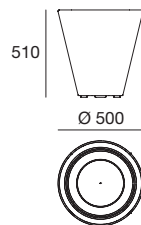
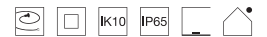

type
White 15055

source
1x46 W Max

optics
diffused

accessories

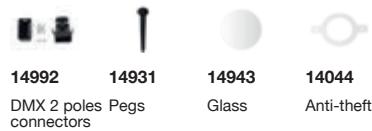

Flower_FL pot | Floor Lamps | 220-240 V | 1 x powerLED 6 W 500 mA

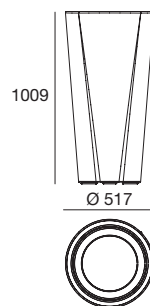

type
White 15056

source
RGB

optics
diffused

electronics accessories

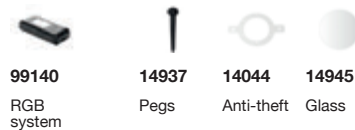

Flower_FL pot | Floor Lamps | 220-240 V | 1xE27

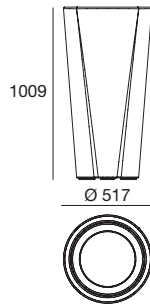
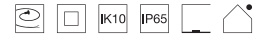

type
White **15057**

source
1x57 W max

optics
diffused

accessories

14992
DMX 2 poles
connectors



14937
Pegs
connectors



14044
Anti-theft



14945
Glass

Flower_FL pot | Floor Lamps | 220-240 V | 1 x powerLED 12 W 500 mA

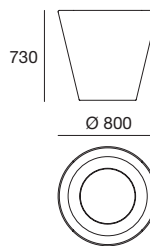

type
White **15052**

source
RGB

optics
diffused

electronics

99140
RGB
system

accessories

14937
Pegs



14040
Weight



14041
Anti-theft



14942
Glass

Flower_FL pot | Floor Lamps | 220-240 V | 1xE27

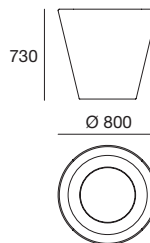
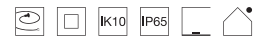

type
White **15053**

source
1x57 W max

optics
diffused

accessories

14992
DMX 2 poles
connectors



14937
Pegs
connectors



14040
Weight



14041
Anti-theft



14942
Glass

Electronics. **INDEX**

Lise | Multi Power 100~240V AC / 180~275V DC

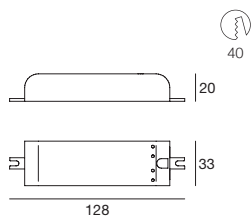

range	output	input	eff.	PF	surge	
2,5~70 W Bulbs Halo	12 V AC	230~240 V AC	91%	0.97	1 kV	57350
2,5~50 W Bulbs LED	12 V AC	230~240 V AC	91%	0.97	1 kV	

Werner | On/Off Driver 220~240 V AC

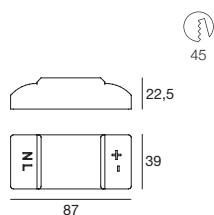

range	output	input	eff.	PF	surge	
7,5 W arrayLED	200mA 37 V	220~300V AC	80%	0.8 C	0,5 kV	62423
9,3 W arrayLED	250mA 37 V	220~240 V AC	83%	0.8 C	0,5 kV	62424

Ludwig | Push 1-10 V Multi Power 110~240 V AC / 176~280 V DC

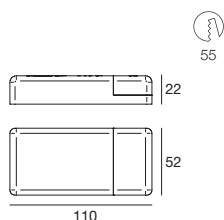

range	output	input	eff.	PF	surge	
7,3 W arrayLED	220mA 37 V	220~240 V AC	87%	0.95	2 kV	62431
9,3 W arrayLED	250mA 37 V	220~240 V AC	87%	0.95	2 kV	

Andre | Push and Simply Dim 1-10 V Multi Power 220~240 V AC / 220~240 V DC

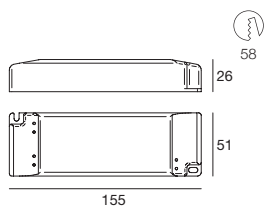

range	output	input	eff.	PF	surge	
7,3 W arrayLED	200mA 37 V	220~240 V AC	87%	0.96	2 kV	62432
9,3 W arrayLED	250mA 37 V	220~240 V AC	87%	0.96	2 kV	

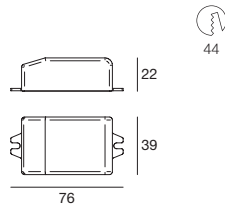
Hans | On/Off Driver 220~240 V AC

44

range	output	input	eff.	PF	surge
2-8 W powerLEDs	700mA 14 V	220-240 V AC -	0.95	0,5	kV 62437

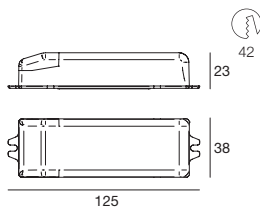
Hugo | On/Off Driver 220~240 V AC / 220~240 V DC

42

range	output	input	eff.	PF	surge
12-24 powerLEDs	700mA 42 V	220~240 V AC -	0.95	1	kV 62439

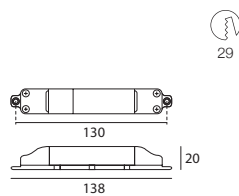
Slim | On/Off Driver 190~250V AC / 180~275V DC

29

range	output	input	eff.	PF	surge
1-2 W powerLED	350mA 6.6V	190~250V AC	80%	0.6 C	4 kV 89144
3-6 W powerLEDs	350mA 20V	190~250V AC	80%	0.6 C	4 kV 89145
1,5-3 W powerLEDs	500mA 6.6V	190~250V AC	80%	0.6 C	4 kV 99195

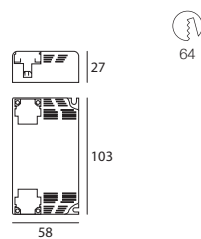
Leon_Easy-Plug | On/Off Driver 180~300V AC

64

range	output	input	eff.	PF	surge
15 W arrayLED	400mA 37V	180~300V AC	91%	0.95	4 kV 99113
25 W arrayLED	720mA 37V	180~300V AC	91%	0.95	4 kV 99112
30 W arrayLED	840mA 37V	180~300V AC	91%	0.95	4 kV 99093

Leon | On/Off Driver 180~300V AC

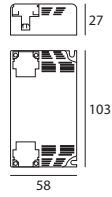

range	output	input	eff.	PF	surge
18 W arrayLED	500mA 37V	180~300V AC	91%	0.95	4 kV 99106

Photon | Push and Simply Dim DALI Multi Power 190~250V AC / 180~275V DC

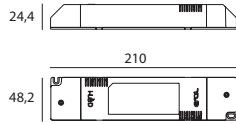

range	output	input	eff.	PF	surge
12,5 W arrayLED	350mA 37V	190~250V AC	87%	0.6 C	4 kV 99114
1-15 W powerLEDs	350mA 45V	190~250V AC	87%	0.6 C	4 kV
18 W arrayLED	500mA 37V	190~250V AC	87%	0.6 C	4 kV
1,5 - 18 W powerLEDs	500mA 37V	190~250V AC	87%	0.6 C	4 kV
20 W arrayLED	630mA 33V	190~250V AC	87%	0.6 C	4 kV
2-20 powerLEDs	630mA 33V	190~250V AC	87%	0.6 C	4 kV

Boson | N/O button 1-10V Multi Power 190~250V AC / 180~275V DC

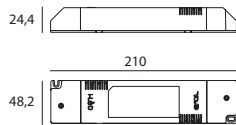

range	output	input	eff.	PF	surge
12,5 W arrayLED	350mA 37V	190~250V AC	87%	0.6 C	4 kV 99115
15 W topLED	350mA 45V	190~250V AC	87%	0.6 C	4 kV
18 W arrayLED	500mA 37V	190~250V AC	87%	0.6 C	4 kV
1,5 - 18 W powerLEDs	500mA 37V	190~250V AC	87%	0.6 C	4 kV
20 W arrayLED	630mA 33V	190~250V AC	87%	0.6 C	4 kV
2-20 W powerLEDs	630mA 33V	190~250V AC	87%	0.6 C	4 kV

Boson_Easy-Plug | N/O button 1-10V Multi Power 190~250V AC / 180~275V DC

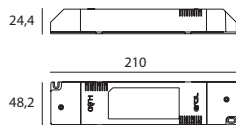

range	output	input	eff.	PF	surge
8 W topLED	220mA 37V	190~250V AC	87%	0.6 C	4 kV 99116



Simon | On/Off Driver 180~300V AC

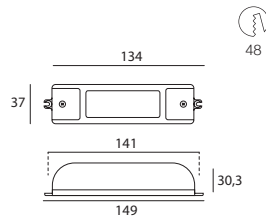

range	output	input	eff.	PF	surge
12,5 W arrayLED	350mA 38V	180~300V AC	89%	0.9 C	4 kV 99126
4,5-9 W powerLEDs	500mA 20V	180~300V AC	89%	0.9 C	4 kV 99128

Photon_Easy-Plug | Push and Simply Dim DALI Multi Power 190~250V AC / 180~275V DC

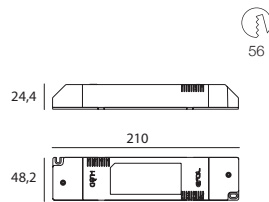

range	output	input	eff.	PF	surge
8 W topLED	220mA 37V	190~250V AC	87%	0.6 C	4 kV 99131

Serban_Easy-Plug | Push and Simply Dim DALI 1-10V Multi Power 190~250V AC / 180~275V DC

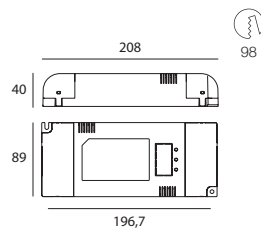

range	output	input	eff.	PF	surge
25 W arrayLED	720mA 37V	190~250V AC	86%	0.95	4 kV 99188
25 W topLED	720mA 36V	190~250V AC	86%	0.95	4 kV
30 W arrayLED	840mA 37V	190~250V AC	86%	0.95	4 kV 99187
30 W topLED	840mA 36V	190~250V AC	86%	0.95	4 kV

Argo_Easy-Plug | Push and Simply Dim DALI Multi Power 190~250V AC / 180~275V DC

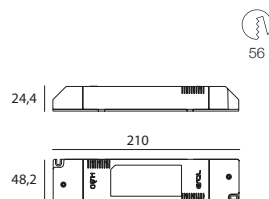

range	output	input	eff.	PF	surge
25 W topLED	720mA 36V	190~250V AC	87%	0.95	4 kV 99330
30 W topLED	840mA 36V	190~250V AC	87%	0.95	4 kV

Argo | Push and Simply Dim DALI Multi Power 190~250V AC / 180~275V DC

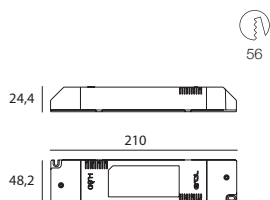

range	output	input	eff.	PF	surge
1-12 w powerLEDs	350mA 39V	190~250V AC	87%	0.95	4 kV 99344
1,5-18 W powerLEDs	500mA 39V	190~250V AC	87%	0.95	4 kV
2-24 W powerLEDs	630mA 39V	190~250V AC	87%	0.95	4 kV

KIT72 | On/Off Driver 220~240V AC

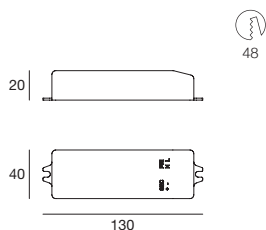
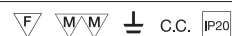

range	output	input	eff.	PF	surge
20 W topLED	500mA	220~240V AC	-	0.95	- KIT72
20 W powerLED	500mA	220~240V AC	-	0.95	-

KIT73 | On/Off Driver 220~240V AC / 176-276V DC

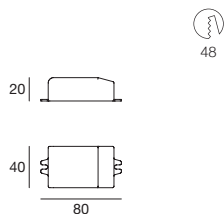
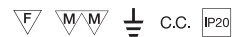

range	output	input	eff.	PF	surge
8 W powerLEDs	500mA	220~240V AC	-	0.6	- KIT73

KIT86 | On/Off Driver 220~240V AC 50 W

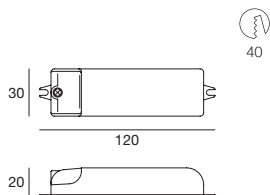

range	output	input	eff.	PF	surge
5-50 W LED Bulbs	12V	220~240V AC	85%	-	- KIT86

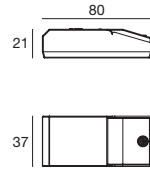
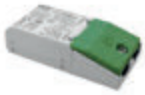
KIT0064 | Phase-cut Driver 220~240V AC

range	output	input	eff.	PF	surge	
10 W topLED	500 mA	220~240V AC	80%	0.97	-	KIT0064

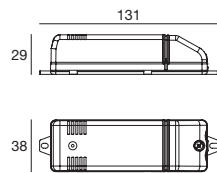
KIT0065 | Phase-cut Driver 220~240V AC

range	output	input	eff.	PF	surge	
25 W topLED	500 mA	220~240V AC	85%	0.94	-	KIT0065

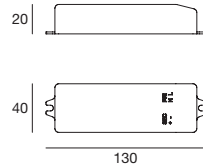
KIT0066 | On/Off Driver 220~240V AC

range	output	input	eff.	PF	surge	
15 W topLED	350 mA	220~240V AC	-	0.95	-	KIT0066

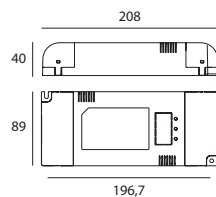
RGB System | N/O button Multi Channel and Power 3ch. 190~250V AC / 180~275V DC

range (3 ch. x)	output	input	eff.	PF	surge	
0.6-8.4 W powerLEDs/ch.	220mA 39V	190~250V AC	86%	0.9	C2 kV	99140
1-12 W powerLEDs/ch.	350mA 39V	190~250V AC	86%	0.9	C2 kV	
1.5-18 W powerLEDs/ch.	500mA 39V	190~250V AC	86%	0.9	C2 kV	

**99125**

IR Remote

**99024**

IR sensor

**99023**

IR sensor

Protection against overtemperature, overload, open circuits and short circuits on the output line. 3-channel device to manage from 1 to 12 LEDs per channel fitted with input for IR receiver or N.O. button. Each driver may be used as master or slave. A driver used in the master mode can control up to 20 slave devices. Driver compatible with the power supply units of the Smith (99076) series.

code. **INDEX**

CODE INDEX /

code	family	page	code	family	page	code	family	page
1002	Mille_W1	101	2642	Mami_tab	359	4423	Campana_W	224
1003	Mille_W1	102	2644	Mami_P1	357	4425	Campana_W	224
1004	Mille_W1	102	2645	Mami_P1	357	4428	Campana_S	224
1005	Mille_W2	102	2646	Mami_P1	357	4429	Campana_W	224
1010	Mille_SB	101	2647	Mami_P3	358	4430	Campana_P	223
1011	Mille_SB	101	2649	Mami_S3	358	4431	Campana_P	223
1015	Mille_W2	102	2653	Mami_S3	358	4432	Campana_P	223
1017	Mille_P	100	2654	Mami_W2	359	4433	Campana_P	223
1018	Mille_P	100	2655	Mami_W1	359	4480	Syberia_S	367
1022	Mille_W1	101	2656	Mami_W2	359	4481	Syberia_S	368
1023	Mille_W1	102	2657	Mami_S5	358	4482	Syberia_S	368
1024	Mille_W1	102	2920	Marina_S	344	4490	Syberia_S	368
1025	Mille_W2	102	2922	Marina_S	344	4491	Syberia_S	368
1030	Curvè	109	2924	Marina_S	344	4492	Syberia_S	369
1031	Curvè	109	2925	Marina_W	345	4514	Syberia_W	369
1032	Curvè	109	2940	Marina_S	344	4524	Syberia_W	369
1040	Mille_SB	101	2942	Marina_S	344	4600	Orbis_W	215
1041	Mille_SB	101	2944	Marina_S	344	4602	Orbis_W	215
1045	Mille_W2	102	2945	Marina_W	345	4603	Orbis_W	215
1131	Curvè	109	3260	Fotis_fix	436	4604	Orbis_P	214
1135	Curvè	109	3261	Fotis_fix	436	4606	Orbis_S	215
1136	Curvè	109	3262	Fotis_fix	436	4609	Orbis_S	214
1140	Curvè	108	3270	Fotis_Q	437	4610	Orbis_P	214
1141	Curvè	108	3271	Fotis_Q	437	4649	Artic_P	365
1143	Curvè	108	3272	Fotis_Q	437	4650	Artic_S	365
1144	Curvè	108	3276	Fotis_fix	436	4652	Artic_S	366
1146	Curvè	108	3372	Fotis_Q	437	4654	Artic_S	366
1147	Curvè	108	3430	Delta_S	334	4662	Artic_W	367
1150	Spotty_W	206	3431	Delta_S	335	4663	Artic_S	366
1152	Spotty_W	207	3432	Delta_S	335	4664	Artic_S	366
1153	Spotty_W	207	3435	Delta_W	335	4668	Artic_W	367
1154	Spotty_S	206	3440	Delta_S	334	4669	Artic_W	367
1155	Spotty_S	206	3441	Delta_S	335	4700	Box_SQ	64
1156	Fotis_mirror	437	3442	Delta_S	335	4701	Box_SQ	64
1157	Spotty_tab	208	3445	Delta_W	335	4702	Box_SQ	64
1158	Spotty_FL	207	3568	Mille_SQ	100	4703	Box_SQ	64
1190	Curvè	108	3569	Mille_SQ	100	4897	Gluèd_PQ1	78
1191	Curvè	108	3670	Fotis_R	436	4899	Gluèd_PQ2	78
1192	Curvè	108	3672	Fotis_R	436	5008	Boll_1	430
2400	Onda_S	343	3674	Fotis_R	436	5009	Boll_2	430
2403	Onda_S	343	3694	Solid	424	5010	Boll_3	430
2405	Onda_S	343	3696	Solid	424	5011	Boll_4	431
2408	Onda_S	343	4402	Campana_W	224	5090	Bilancia_tab	327
2638	Mami_P1	357	4403	Campana_W	224	5093	Bilancia_S	327
2639	Mami_P2	358	4405	Campana_W	224	5094	Bilancia_S	327
2641	Mami_W1	359	4422	Campana_W	224	5095	Bilancia_S	327

code	family	page	code	family	page	code	family	page
6360	Incasso_1	148	6996	Zig Zag_W	253	7347	Spotty_W	207
6361	Incasso_2	148	6999	Zig Zag_W	253	7348	Spotty_S	206
6364	Incasso_R	148	7001	Zig Zag_W	253	7349	Spotty_S	206
6410	Cubic	441	7002	Zig Zag_W	253	7350	Spotty_FL	207
6413	Cubic	441	7005	Zig Zag_W	253	7352	Spotty_tab	208
6414	Cubic	441	7006	Zig Zag_W	253	7400	Zig Zag_S	252
6610	Pelota_W2	201	7151	Plaf	488	7401	Zig Zag_S	252
6611	Pelota_W2	201	7220	Snake_W1	129	7402	Zig Zag_S	252
6612	Pelota_W2	201	7221	Snake_W1	129	7475	Face_P	256
6613	Pelota_W1	201	7223	Snake_W1	129	7476	Face_S	256
6614	Pelota_W1	201	7224	Snake_W1	129	7477	Face_S	257
6615	Pelota_W1	201	7226	Snake_W3	130	7478	Face_S	257
6616	Pelota_S	201	7227	Snake_W3	130	7479	Face_W	257
6617	Pelota_S	201	7229	Snake_W2	130	7485	Dublight_W	90
6618	Pelota_S	201	7230	Snake_W2	130	7486	Dublight_W	90
6668	Gluèd_PQ1	78	7232	Snake_W1	130	7487	Dublight_W	90
6720	Box_W	65	7233	Snake_W1	130	7488	Dublight_S	89
6721	Box_W	65	7234	Snake_W3	130	7489	Dublight_S	89
6722	Box_W	65	7235	Snake_W3	130	7490	Dublight_S	89
6723	Box_W	65	7241	Goccia_W	431	7491	Dublight_S	89
6724	Box_W	65	7243	Goccia_tab	431	7492	Dublight_P	88
6725	Box_W	65	7248	Conus_P1	121	7493	Dublight_P	88
6726	Box_W	65	7251	Conus_S1	122	7494	Dublight_P	88
6727	Box_W	65	7254	Conus_P1	121	7495	Dublight_tab	91
6728	Box_W	65	7257	Conus_S1	122	7496	Dublight_FL	90
6729	Box_W	65	7269	Conus_C	121	7530	Conus_P1	121
6730	Box_W	65	7272	Conus_S2	122	7531	Conus_S1	122
6731	Box_W	65	7275	Conus_P2	121	7532	Conus_P1	121
6732	Box_W	66	7278	Conus_tab	122	7533	Conus_S1	122
6733	Box_W	66	7280	Conus_tab	122	7536	Conus_C	121
6734	Box_W	66	7281	Conus_tab	122	7537	Conus_S2	122
6735	Box_W	66	7284	Conus_FL	121	7538	Conus_P2	121
6835	Pelota_P	201	7287	Conus_S3	122	7540	Conus_tab	122
6836	Pelota_P	201	7289	Zig Zag_S	252	7541	Conus_FL	121
6837	Pelota_P	201	7290	Zig Zag_S	252	7542	Conus_S3	122
6845	Mille_W1	101	7291	Zig Zag_S	252	7618	One to One_S	138
6846	Mille_W1	101	7292	Zig Zag_S	253	7619	One to One_C	138
6905	Elipse	441	7293	Zig Zag_S	253	7626	Squash_S	39
6906	Dice	441	7294	Zig Zag_S	253	7627	Squash_P	38
6931	Artic_P	365	7340	Spotty_W	206	7628	Squash_FL	39
6986	Zig Zag_W	253	7341	Spotty_W	207	7640	One to One_S	138
6989	Zig Zag_W	253	7342	Spotty_W	207	7641	One to One_S	138
6990	Zig Zag_W	253	7343	Spotty_S	206	7642	One to One_C	138
6991	Zig Zag_P	252	7344	Spotty_S	206	7643	One to One_C	138
6994	Zig Zag_P	252	7345	Spotty_W	206	7655	Rose_P	70
6995	Zig Zag_P	252	7346	Spotty_W	207	7656	Rose_S	70

CODE INDEX /

code	family	page	code	family	page	code	family	page
7657	Rose_P	70	7836	Mille_W1	98	8028N	MiniWhite_R	482
7658	Rose_S	70	7838	Mille_W1	98	8029	MiniWhite_Q	483
7725	Thank You_W3 naked	240	7840	Mille_W1	98	8029N	MiniWhite_Q	483
7726	Thank You_W3 naked	240	7842	Mille_W1	98	8045	Thank You_tab	238
7727	Thank You_W2 naked	239	7844	Mille_W1	99	8046	Thank You_tab	238
7728	Thank You_W2 naked	239	7846	Mille_W1	99	8047	Thank You_tab	238
7733	Thank You_FL naked	240	7848	Mille_W1	99	8048	Thank You_tab	238
7734	Thank You_FL naked	240	7850	Mille_W2	99	8049	Thank You_S	237
7805	MyWhite_R	482	7852	Mille_SB	97	8050	Thank You_S	237
7805N	MyWhite_R	482	7854	Mille_SB	97	8051	Thank You_S	237
7806	MyWhite_R	482	7857	Snake_W4	131	8052	Thank You_S	237
7806E	MyWhite_R	483	7858	Snake_W4	131	8053	Thank You_W1	237
7806N	MyWhite_R	482	7859	Snake_S	129	8054	Thank You_W1	237
7806NE	MyWhite_R	483	7860	Snake_S	129	8055	Thank You_W1	237
7806NS	MyWhite_R	482	7861	Snake_FL	131	8056	Thank You_W1	237
7806S	MyWhite_R	482	7862	Snake_FL	131	8057	Thank You_P	236
7807	MyWhite_Q	483	7885	Dublight_C tab	91	8058	Thank You_P	236
7807N	MyWhite_Q	483	7886	Dublight_C tab	91	8059	Thank You_P	236
7808	MyWhite_Q	483	7889	MyWhite_U	481	8060	Thank You_P	236
7808E	MyWhite_Q	484	7890	MyWhite_U	481	8061	Thank You_P	236
7808N	MyWhite_Q	483	7891	Stardust_P	45	8062	Thank You_P	236
7808NE	MyWhite_Q	484	7892	Stardust_P	45	8063	Thank You_P	236
7808NS	MyWhite_Q	484	7893	Stardust_S	45	8064	Thank You_P	236
7808S	MyWhite_Q	484	7894	Stardust_S	45	8065	Thank You_P	236
7809	MyWhite_Q	484	7904	Kioo	405	8066	Thank You_P	236
7809N	MyWhite_Q	484	7905	Kioo	405	8067	Thank You_P	236
7810	MyWhite_Q	484	7906	Kioo	405	8068	Thank You_P	236
7810E	MyWhite_B	485	7907	Kioo	405	8069	Thank You_W3	237
7810N	MyWhite_Q	484	7908	Skinny	411	8070	Thank You_W3	237
7810NE	MyWhite_B	485	7909	Skinny	411	8071	Thank You_W3	237
7810NS	MyWhite_B	485	7910	Skinny	411	8072	Thank You_W3	237
7810S	MyWhite_B	485	7911	Skinny	411	8073	Thank You_W2	237
7811	Prime	419	7914	Aloha	419	8074	Thank You_W2	237
7812	Prime	419	7915	Aloha	419	8075	Thank You_W2	237
7813	Prime	419	7946	Squash_tab	39	8076	Thank You_W2	237
7814	Prime	419	7947	Squash_tab	39	8077	Thank You_FL	238
7815	Prime	419	7948	Squash_P	38	8078	Thank You_FL	238
7816	Prime	419	7951	Squash_S	38	8079	Thank You_FL	238
7820	Move_S	33	7956	Bart_W	135	8080	Thank You_FL	238
7821	Move_S	33	7957	Bart_W	135	8160	Box_R Full light	52
7823	Move_P	33	7972	Beebo_W	143	8160N	Box_R Full light	52
7824	Move_P	33	7973	Beebo_W	143	8162	Box_Q Full light	52
7826	Move_S	33	7974	Beebo_W	143	8162N	Box_Q Full light	52
7827	Move_S	33	8027	MyWhite_U	481	8195	Tu-V	28
7829	Move_P	33	8027N	MyWhite_U	481	8196	Tu-V	28
7830	Move_P	33	8028	MiniWhite_R	482	8197	Tu-V	28

code	family	page	code	family	page	code	family	page
8198	Tu-O	28	8238	Box_SR	60	8271	Crew_1	261
8199	Tu-O	28	8238N	Box_SR	60	8272	Crew_1	261
8200	Straight_P1	23	8239	Box_SR	60	8275	Crew_1	261
8201	Straight_P1	23	8239N	Box_SR	60	8276	Crew_1	261
8202	Straight_P3	23	8240	Box_SR	60	8277	Crew_1	261
8203	Straight_P3	23	8240N	Box_SR	60	8280	Crew_1	261
8204	Straight_P1	23	8241	Box_SR	60	8281	Crew_1	261
8205	Straight_P1	23	8241N	Box_SR	60	8282	Crew_1	261
8206	Straight_P3	23	8242	Box_SR	61	8285	Crew_2	262
8207	Straight_P3	23	8242N	Box_SR	61	8286	Crew_2	262
8208	Straight_W	395	8243	Box_SR	61	8287	Crew_2	262
8209	Straight_W	395	8243N	Box_SR	61	8288	Crew_2	262
8210	Straight_W	395	8245	Zebra_W	280	8289	Crew_2	262
8211	Straight_W	395	8246	Zebra_W	280	8292	Crew_2	262
8215	Thank You_tab naked	240	8247	Zebra_S	280	8293	Crew_2	262
8216	Thank You_tab naked	240	8248	Zebra_S	281	8294	Crew_2	262
8217	Thank You_S naked	239	8249	Zebra_S	281	8295	Crew_2	262
8218	Thank You_S naked	239	8253	Box_SB	62	8296	Crew_2	262
8219	Thank You_W1 naked	239	8253N	Box_SB	62	8299	Crew_2	262
8220	Thank You_W1 naked	239	8254	Box_SB	62	8300	Crew_2	262
8221	Thank You_P naked	239	8254N	Box_SB	62	8301	Crew_2	262
8222	Thank You_P naked	239	8255	Box_W	63	8302	Crew_2	262
8225	Box_C	61	8255N	Box_W	63	8303	Crew_2	262
8225N	Box_C	61	8256	Box_W	63	8306	Crew_3	262
8226	Box_C	61	8256N	Box_W	63	8307	Crew_3	262
8226N	Box_C	61	8257	Box_W	63	8308	Crew_3	262
8227	Box_SQ	61	8257N	Box_W	63	8311	Crew_3	263
8227N	Box_SQ	61	8258	Box_W	63	8312	Crew_3	263
8228	Box_SQ	61	8258N	Box_W	63	8313	Crew_3	263
8228N	Box_SQ	61	8259	Box_SB	62	8316	Crew_3	263
8229	Box_SQ	61	8259N	Box_SB	62	8317	Crew_3	263
8229N	Box_SQ	61	8260	Box_SB	62	8318	Crew_3	263
8230	Box_SQ	61	8260N	Box_SB	62	8325	Tara_Q	267
8230N	Box_SQ	61	8261	Box_W	63	8328	Tara_Q	267
8231	Box_SQ	62	8261N	Box_W	63	8331	Tara_Q	267
8231N	Box_SQ	62	8262	Box_W	63	8334	Tara_R	268
8232	Box_SQ	62	8262N	Box_W	63	8337	Tara_R	268
8232N	Box_SQ	62	8263	Box_W	63	8340	Tara_R	268
8233	Box_SQ	62	8263N	Box_W	63	8345	Poe_FL	287
8233N	Box_SQ	62	8264	Box_W	63	8346	Poe_FL	287
8234	Box_SQ	62	8264N	Box_W	63	8347	Poe_FL	287
8234N	Box_SQ	62	8265	Straight_W	395	8350	Poe_P	287
8236	Box_SR	60	8266	Straight_W	395	8351	Poe_P	287
8236N	Box_SR	60	8267	Straight_W	395	8352	Poe_P	287
8237	Box_SR	60	8268	Straight_W	395	8365	Joshua	277
8237N	Box_SR	60	8270	Crew_1	261	8366	Joshua	277

CODE INDEX /

code	family	page	code	family	page	code	family	page
8369	Incasso_CJ1	147	8460	Beebo_S	143	10224	Oh!_PM	381
8370	Incasso_CJ1	147	8461	Beebo_S	143	10225	Oh!_PM	381
8372	Incasso_CJ2	148	8462	Beebo_S	143	10330	Vulcano_P	249
8373	Incasso_CJ2	148	8466	Bart_S	135	10331	Vulcano_S	249
8375	Incasso_C1	147	8467	Bart_S	135	10335	Vulcano_P	249
8376	Incasso_C1	147	8470	Outlook_C	195	10336	Vulcano_S	249
8379	Incasso_C2	147	8472	Outlook_S	195	10380	Ohps_FL	387
8380	Incasso_C2	147	10000	Marge_FL65	523	10381	Ohps_FL	387
8384	Sisters_2	245	10001	Marge_FL65	523	10382	Ohps_P	386
8385	Sisters_2	245	10013	Accessories	523-526	10383	Ohps_P	386
8386	Sisters_2	245	10015	Accessories	523	10386	Ohps_S	386
8387	Sisters_1	245	10100	Oh!_FL	383	10387	Ohps_S	387
8388	Sisters_1	245	10101	Oh!_P	380	14020	Accessories	526
8389	Sisters_1	245	10102	Oh!_FL	383	14040	Accessories	531-532-533
8390	Halfpipe	401	10103	Oh!_P	380	14041	Accessories	531-532-533
8391	Halfpipe	401	10104	Oh!_FL	383	14042	Accessories	533
8392	Halfpipe	401	10105	Oh!_P	380	14043	Accessories	532-533
8395	Halfpipe	401	10106	Oh!_FL	383	14044	Accessories	532-533
8396	Halfpipe	401	10107	Oh!_P	380	14045	Accessories	532-533
8397	Halfpipe	401	10110	Oh!_FL	383	14080	Accessories	498-499-500-501
8400	Halfpipe	401	10111	Oh!_P	380	14081	Accessories	498-499-500-501
8401	Halfpipe	401	10114	Oh!_P	378	14082	Accessories	498-499-500-501
8402	Halfpipe	401	10115	Oh!-C	447	14083	Accessories	498-499-500
8405	Circular	415	10116	Oh!-C	447	14100	Accessories	504-505
8409	Circular	415	10117	Oh!_PMX	379	14930	Accessories	498-499-500-501-504-505-510-511-531-532
8413	Circular	415	10122	Oh!_S	382	14931	Accessories	498-499-500-501-504-505-510-511-532
8420	Outlook_P	195	10124	Oh!_S	382	14937	Accessories	523-526-531-532-533
8425	Trix-C30_1	468	10126	Oh!_S	382	14991	Accessories	526
8426	Trix-C30_1	468	10128	Oh!_S	382	14992	Accessories	499-500-510-511
8427	Trix-C30_2	468	10130	Oh!_S	382	15000	Baby Marge	291
8428	Trix-C30_2	468	10131	Oh!_S	379	15050	Flower_FL table	531
8429	Trix-C	447	10132	Oh!_S	379	15051	Flower_FL table	531
8430	Trix-C	447	10133	Oh!_S	379			
8435	Tablet-C15	456	10134	Oh!_S	379			
8436	Tablet-C15	456	10135	Oh!_P	378			
8437	Tablet_C30	468	10136	Oh!_P	378			
8438	Tablet-C30	468	10137	Oh!_P	378			
8442	Beebo-C30	469	10138	Oh!_P	378			
8443	Beebo-C30	469	10213	Oh! Smash_P	390			
8445	Circular-C	447	10214	Oh! Smash_S	390			
8446	Circular-C	447	10215	Oh! Smash_FL	391			
8455	Heli	113	10216	Oh! Smash_P	390			
8456	Heli	113	10217	Oh! Smash_S	391			
8457	Heli	113	10218	Oh! Smash_FL	391			
8458	Heli	113	10220	Oh!_PM	381			
8459	Heli	113	10221	Oh!_PM	381			

code	family	page	code	family	page	code	family	page
15052	Flower_FL pot	533	15194	Oh!_FL65	499	53225	Cable System_acces.	460-473
15053	Flower_FL pot	533	15200	Peggy_FL	526	53234	Cable System_acces.	450
15054	Flower_FL pot	532	15201	Peggy_FL	526	53235	Cable System_acces.	450
15055	Flower_FL pot	532	15202	Peggy_FL	526	54284	Matrix-C30_2	469
15056	Flower_FL pot	532	15213	Oh! Smash_P65	508	54285	Matrix-C30_2	469
15057	Flower_FL pot	533	15214	Oh! Smash_S65	509	57350	Electronics	536
15058	Flower_FL seat	531	15215	Oh! Smash_FL65	510	59114	Orion-C15_J	457
15059	Flower_FL seat	532	15216	Oh! Smash_P65	509	59115	Orion-C15_J	457
15105	Oh!_S65	497	15217	Oh! Smash_S65	510	59134	Matrix-C15	457
15106	Oh!_P65	496	15218	Oh! Smash_FL65	510	59135	Matrix-C15	457
15109	Oh!_S65	497	15219	Oh! Smash_FL65	510	59223	Halley-C15_2	458
15110	Oh!_P65	496	15220	Oh! Smash_FL65	510	59228	Halley-C15_2	458
15111	Oh!_P65	496	15221	Oh! Smash_FL65	510	59229	Halley-C15_2	458
15112	Oh!_S65	497	15222	Oh! Smash_FL65	510	59530	Point-C30	470
15113	Oh!_P65	496	15223	Oh! Smash_S65	509	59531	Point-C30	470
15114	Oh!_S65	497	15224	Oh! Smash_P65	508	59532	Point-C15	458
15115	Oh!_P65	496	15225	Oh! Smash_S65	509	59533	Point-C15	458
15120	Oh! Solar	515	15226	Oh! Smash_P65	508	59538	Point-C	448
15130	Oh!_Mars	501	15380	Ohps_FL65	505	59539	Point-C	448
15131	Oh!_Mars	501	15381	Ohps_FL65	504	59734	Orient-C_2	447
15132	Oh!_Mars	501	15382	Ohps_FL	505	59735	Orient-C_2	447
15133	Oh!_Mars	501	15383	Ohps_FL	505	59744	Orion-C_2	447
15150	Oh!_FL65	500	15384	Ohps_FL65	504	59745	Orion-C_2	447
15156	Oh!_FL65	498	15385	Ohps_FL65	505	59754	Orion-C_1	447
15158	Oh!_UW	518	15386	Ohps_S65	504	60595	Gypsum_QC4	176
15160	Oh!_FL65	500	15387	Ohps_S65	504	60680	Gypsum_WF3	190
15161	Oh!_FL65	498	51234	Matrix-C30_3	469	60801	Gypsum_O1	162
15162	Oh!_FL65	500	51235	Matrix-C30_3	469	60802	Gypsum_O1	163
15163	Oh!_FL65	498	51244	Matrix-C30_4	470	60811	Gypsum_WR3	189
15164	Oh!_FL65	500	51245	Matrix-C30_4	470	60813	Gypsum_WR1	187
15165	Oh!_FL65	498	51254	Matrix-C30_1	469	60814	Gypsum_WRQ	188
15166	Oh!_FL65	500	51255	Matrix-C30_1	469	60815	Gypsum_WR2	188
15167	Oh!_FL66	498	51456	Vega-C30_3	471	60816	Gypsum_WX	187
15168	Oh!_P65	496	51535	Orion-C30	470	60817	Gypsum_W2	186
15169	Oh!_P65	496	51545	Orion-C30J	470	60819	Gypsum_W3	187
15170	Oh!_P65	496	51635	Orion-C15_Q	457	60821	Gypsum_O2	162
15180	Oh!_P65	496	51745-TR	Accessories	457	60822	Gypsum_O2	163
15181	Oh!_S65	497	51755	Orion-C15_R	457	60824	Gypsum_O3	162
15183	Oh!_S65	497	53033	Cable System_acces.	450	60827	Gypsum_O4	163
15185	Oh!_S65	497	53034	Cable System_acces.	450	60828	Gypsum_Eye4	165
15187	Oh!_S65	497	53035	Cable System_acces.	450			153-160-
15189	Oh!_S65	497	53038	Cable System_acces.	450			161-162-
15190	Oh!_FL65	499	53204	Cable System_acces.	460-473	60830	Accessories	163-164-
15191	Oh!_FL65	499	53205	Cable System_acces.	460-473			165-166-
15192	Oh!_FL65	499	53214	Cable System_acces.	460-473			174-175-
15193	Oh!_FL65	499	53215	Cable System_acces.	460-473			176-177-
								178-179-
								187-188-
								189-190

CODE INDEX /

code	family	page	code	family	page	code	family	page
60834	Gypsum_W1	186	63820	Gypsum_QD2	177	71690	Luminosa_W	338
60837	Accessories	187-188-189	63830	Gypsum_QD1	177	71691	Luminosa_S	338
60839	Accessories	187	64180	Accessories	189-190	71692	Luminosa_S	338
60840	Accessories	174-175-178	64244	Orient-C_1	447	71877	Liner_W	333
60843	Gypsum_III1	166	64245	Orient-C_1	447	71880	Liner_W	333
60844	Gypsum_III2	166	64500	Gypsum_QC1	174	71883	Liner_S	332
60845	Gypsum_III3	166	64501	Gypsum_D1	178	71886	Liner_S	332
60848	Gypsum_SQ	180	64502	Gypsum_D2	179	71889	Liner_S	332
60851	Gypsum_SR	180	64503	Gypsum_DX	179	71892	Liner_S	333
60852	Gypsum_Eye2	164	64504	Gypsum_D3	179	73398	Sipario	314
60853	Gypsum_Eye3	164	64546	Gypsum_Cell1	153	73399	Sipario	314
60860	Accessories	160-161	64547	Gypsum_Cell1	153	73665	Liner_W	333
60910	Gypsum_WRX	188	64548	Gypsum_Cell2	153	73666	Lancia_S	334
60920	Gypsum_WF1	189	64549	Gypsum_Cell2	153	73667	Lancia_S	334
60930	Gypsum_WF2	189	64550	Gypsum_Cell3	153	73668	Lancia_W	334
60940	Gypsum_WF4	190	64551	Gypsum_Cell3	153	78220	Nove99_W1	315
60980	Gypsum_Eye1	165	64709	Self-C15_R	456	78221	Nove99_W1	315
60990	Gypsum_QC2	174	64710	Self-C15_RJ	456	78222	Nove99_W1	315
61210	Gypsum_QC2	175	64731	Self-C15_R	456	78223	Nove99_W1	315
61230	Gypsum_R2	161	64732	Self-C15_RJ	456	78224	Nove99_W1	315
61250	Gypsum_R1	161	71200	Nove99_S	314	78225	Nove99_W1	315
61270	Accessories	189	71202	Nove99_S	314	89144	Electronics	537
61280	Accessories	189	71204	Nove99_W2	315	89145	Electronics	537
61290	Accessories	190	71226	Nove99_S	314	90206	Triad_W	323
61320	Gypsum_QCY	177	71228	Nove99_S	314	90207	Triad_W	323
61330	Gypsum_R2	160	71230	Nove99_W2	315	90208	Triad_S	322
61340	Gypsum_Eye1	164	71570	Wally	348	90209	Triad_S	323
61350	Gypsum_R1	160	71640	Ecomolla_W	326	90210	Triad_P	322
61360	Accessories	160-161	71641	Ecomolla_S	326	90211	Triad_P	322
61370	Gypsum_EyeJ	165	71642	Ecomolla_S	326	90212	Hula Hoop_S	318
61390	Gypsum_WF4	190	71649	Box_SQ	64	90213	Hula Hoop_W	318
61410	Gypsum_QCY	176	71649/EM	Box_SQ	64	90214	Iceberg_S	345
61430	Gypsum_QRD	178	71650	Box_SQ	64	90215	Iceberg_S	345
61450	Gypsum_QRD	178	71650/EM	Box_SQ	64	90222	Triad_W	323
61800	Gypsum_QC3	175	71651	Box_SQ	64	90223	Triad_W	323
62423	Electronics	536	71651/EM	Box_SQ	64	90224	Triad_S	322
62424	Electronics	536	71652	Box_SQ	64	90225	Triad_S	323
62430	Gypsum_QC4	176	71652/EM	Box_SQ	64	90226	Triad_P	322
62431	Electronics	536	71653	Box_SQ	64	90227	Triad_P	322
62432	Electronics	536	71654	Box_SQ	64	90228	Triad_W	323
62437	Electronics	537	71655	Box_SQ	64	90229	Triad_W	323
62439	Electronics	537	71656	Box_SQ	64	90230	Triad_S	322
62480	Gypsum_QC3	175	71657	Box_SQ	65	90231	Triad_S	323
62660	Gypsum_R3	161	71658	Box_SQ	65	90232	Triad_P	322
			71659	Box_SQ	65	90233	Triad_P	322
			71660	Box_SQ	65	90234	Hula Hoop_W	318

code	family	page	code	family	page	code	family	page
90235	Hula Hoop_S	318	90301	Gluèd_W	81	99140	Electronics	541
90238	Moledro_S	302	90302	Gluèd_SB	79	99187	Electronics	539
90239	Moledro_P	301	90303	Gluèd_SB	79	99188	Electronics	539
90240	Matrioska_W	352	90304	Gluèd_SB	80	99195	Electronics	537
90241	Matrioska_W	352	90305	Gluèd_SB	80	99330	Electronics	539
90242	Matrioska_S	353	90306	Gluèd_SQ	80	99344	Electronics	540
90243	Matrioska_S	353	90307	Gluèd_SQ	80	321B881	Wally	348
90244	Matrioska_P	353	90308	Gluèd_PB	79	327B881	Onda_W	344
90245	Matrioska_W	352	90309	Gluèd_PB	79	327B921	Onda_W	344
90246	Matrioska_W	352	90315	Moledro_W	302	358B881	Onda_W	343
90247	Matrioska_S	353	90316	Moledro_W	302	358B921	Onda_W	343
90248	Matrioska_S	353	90317	Moledro_S	302	536BRA881	MetWally	349
90249	Matrioska_P	353	90318	Moledro_P	301	536K881	MetWally	349
90250	Iceberg_W	345	90320	Metal_W	295	536NS881	MetWally	349
90255	Solido_W	311	90321	Metal_W	295	537BRA881	MetWally	349
90256	Solido_W	311	90322	Metal_W	295	537K881	MetWally	349
90257	Solido_W	311	90323	Metal_W	295	537NS881	MetWally	349
90258	Solido_W	311	90324	Metal_W	295	539BRA881	MetWally	349
90259	Solido_S	311	90325	Metal_W	295	539K881	MetWally	349
90260	Solido_S	311	90326	Metal_S	296	539NS881	MetWally	349
90261	Solido_W	311	90327	Metal_S	296	575RU881	MetWally	349
90262	Solido_W	311	90328	Metal_S	296	576RU881	MetWally	349
90263	Solido_S	311	90329	Metal_S	296	577RU881	MetWally	349
90265	Madera_S1	306	90330	Metal_S	296	KIT01	Accessories	435
90266	Madera_S2	306	90331	Metal_S	296	KIT72	Electronics	540
90267	Madera_W	307	91229	Illuminator_3	167	KIT73	Electronics	540
90268	Madera_W	307	91232	Illuminator_3	167	KIT86	Electronics	540
90269	Madera_S2	306	97476	Illuminator_1	167			38-113- 129-131- 136-138- 143-195
90270	Madera_S2	306	97482	Illuminator_1	167	KIT0026	Accessories	
90271	Madera_S2	306	97485	Illuminator_2	167			
90272	Madera_S2	306	97491	Illuminator_2	167	KIT0064	Electronics	541
90273	Madera_W	307	98071	Accessories	167	KIT0065	Electronics	541
90274	Madera_W	307	98072	Accessories	167	KIT0066	Electronics	496-541
90275	Madera_W	307	98507	Accessories	167	TR4000-3	Vega-C30_1	471
90276	Madera_W	307	98508	Accessories	167	TR4000-5	Vega-C30_1	471
90281	Crumb	219	98509	Accessories	167	TR4000-9	Vega-C30_1	471
90282	Crumb	219	99093	Electronics	537	TR4008-5	Modular-C30_4	471
90285	Horizon_S	49	99106	Electronics	538	TR4014-3	Vega-C30_2	471
90286	Horizon_P	49	99112	Electronics	537	TR4014-5	Vega-C30_2	471
90290	Spark	273	99113	Electronics	537	TR4100-3	Cable System_acces.	472
90291	Spark	273	99114	Electronics	538	TR4100-5	Cable System_acces.	472
90292	Spark	273	99115	Electronics	538	TR4100-8	Cable System_acces.	472
90293	Spark	273	99116	Electronics	538	TR4101-3	Cable System_acces.	473
90294	Spark	273	99126	Electronics	539	TR4101-4	Cable System_acces.	473
90295	Spark	273	99128	Electronics	539	TR4101-5	Cable System_acces.	473
90300	Gluèd_W	81	99131	Electronics	539	TR4101-8	Cable System_acces.	473

CODE INDEX /

code	family	page	code	family	page	code	family	page
TR4101-9	Cable System_acces.	473	TR4113-4	Cable System_acces.	460	TR4151	Cable System_acces.	451
TR4102-3	Cable System_acces.	472	TR4113-5	Cable System_acces.	460	TR4151-10	Cable System_acces.	451-462
TR4102-48	Cable System_acces.	472	TR4113-8	Cable System_acces.	460	TR4151-15	Cable System_acces.	451-462
TR4102-5	Cable System_acces.	472	TR4113-9	Cable System_acces.	460	TR4151-20	Cable System_acces.	451-462
TR4102-9	Cable System_acces.	472	TR4114-3	Cable System_acces.	451	TR4151-25	Cable System_acces.	451-462
TR4103-3	Cable System_acces.	460-473	TR4114-4	Cable System_acces.	451	TR4151-30	Cable System_acces.	451-462
TR4103-4	Cable System_acces.	460-473	TR4114-5	Cable System_acces.	451	TR4151-5	Cable System_acces.	451-462
TR4103-48	Cable System_acces.	460-473	TR4114-8	Cable System_acces.	451	TR4151-50	Cable System_acces.	451-462
TR4103-5	Cable System_acces.	460-473	TR4114-9	Cable System_acces.	451	TR4152	Cable System_acces.	451-462
TR4103-9	Cable System_acces.	460-473	TR4115-3	Cable System_acces.	460	TR4152-10	Cable System_acces.	451-462
TR4104-3	Cable System_acces.	460-473	TR4115-48	Cable System_acces.	460	TR4152-15	Cable System_acces.	451-462
TR4104-8	Cable System_acces.	460-473	TR4115-9	Cable System_acces.	460	TR4152-20	Cable System_acces.	451-462
TR4105-3	Cable System_acces.	473	TR4116-3	Cable System_acces.	460	TR4152-25	Cable System_acces.	451-462
TR4105-5	Cable System_acces.	473	TR4116-48	Cable System_acces.	460	TR4152-30	Cable System_acces.	451-462
TR4105-8	Cable System_acces.	473	TR4116-9	Cable System_acces.	460	TR4152-5	Cable System_acces.	451-462
TR4106-3	Cable System_acces.	473	TR4117-3	Cable System_acces.	451	TR4152-50	Cable System_acces.	451-462
TR4106-48	Cable System_acces.	473	TR4117-8	Cable System_acces.	451	TR4200-3	Halley-C15_1	458
TR4106-5	Cable System_acces.	473	TR4117-9	Cable System_acces.	451	TR4200-48	Halley-C15_1	458
TR4107-3	Cable System_acces.	472	TR4118-3	Cable System_acces.	450	TR4201-3	Halley-C15_J1	458
TR4107-48	Cable System_acces.	472	TR4118-48	Cable System_acces.	450	TR4201-48	Halley-C15_J1	458
TR4107-5	Cable System_acces.	472	TR4118-9	Cable System_acces.	450	TR4202-3	Halley-C15_J2	459
TR4107-9	Cable System_acces.	472	TR4119-3	Cable System_acces.	451	TR4202-48	Halley-C15_J2	459
TR4108-3	Cable System_acces.	472	TR4119-4	Cable System_acces.	451	TR4217-9	Bell-C15	459
TR4108-5	Cable System_acces.	472	TR4119-48	Cable System_acces.	451	TR4302-3	Tek-C_1	448
TR4108-8	Cable System_acces.	472	TR4119-5	Cable System_acces.	451	TR4302-48	Tek-C_1	448
TR4109-3	Cable System_acces.	460-472	TR4119-9	Cable System_acces.	451	TR4302-9	Tek-C_1	448
TR4109-4	Cable System_acces.	460-472	TR4120-3	Cable System_acces.	451	TR4303-3	Andromeda-C_2	448
TR4109-5	Cable System_acces.	460-472	TR4120-8	Cable System_acces.	451	TR4303-48	Andromeda-C_2	448
TR4109-8	Cable System_acces.	460-472	TR4121-3	Cable System_acces.	460	TR4303-9	Andromeda-C_2	448
TR4109-9	Cable System_acces.	460-472	TR4121-5	Cable System_acces.	460	TR4304-3	Andromeda-C_1	448
TR4110-3	Cable System_acces.	460-472	TR4121-8	Cable System_acces.	460	TR4304-48	Andromeda-C_1	448
TR4110-4	Cable System_acces.	460-472	TR4121-9	Cable System_acces.	460	TR4304-9	Andromeda-C_1	448
TR4110-5	Cable System_acces.	460-472	TR4122-3	Cable System_acces.	460	TR4307-3	Tek-C_2	449
TR4110-8	Cable System_acces.	460-472	TR4122-48	Cable System_acces.	460	TR4307-48	Tek-C_2	449
TR4110-9	Cable System_acces.	460-472	TR4123-3	Cable System_acces.	450	TR4307-9	Tek-C_2	449
TR4111-3	Cable System_acces.	450	TR4123-48	Cable System_acces.	450	TR4310-3	Virgo-C	449
TR4111-4	Cable System_acces.	450	TR4124-3	Cable System_acces.	460-473	TR4310-48	Virgo-C	449
TR4111-5	Cable System_acces.	450	TR4124-8	Cable System_acces.	460-473	TR4317-9	Bell-C	449
TR4111-8	Cable System_acces.	450	TR4150	Cable System_acces.	460			
TR4111-9	Cable System_acces.	450	TR4150-10	Cable System_acces.	460			
TR4112-3	Cable System_acces.	450	TR4150-15	Cable System_acces.	460			
TR4112-4	Cable System_acces.	450	TR4150-20	Cable System_acces.	460			
TR4112-5	Cable System_acces.	450	TR4150-25	Cable System_acces.	460			
TR4112-8	Cable System_acces.	450	TR4150-30	Cable System_acces.	460			
TR4112-9	Cable System_acces.	450	TR4150-5	Cable System_acces.	460			
TR4113-3	Cable System_acces.	460	TR4150-50	Cable System_acces.	460			

FAMILY INDEX /

name	page	name	page	name	page
ALOHA	P. 416	JOSHUA	P. 275	STRAIGHT_W	P. 392
ARTIC	P. 360	KIOO	P. 402	SYBERIA	P. 360
BABY MARGE	P. 288	LANCIA	P. 328	TARA	P. 264
BART	P. 133	LINER	P. 328	THANK YOU	P. 226
BEEBO	P. 140	LUMINOSA	P. 336	TRIAD	P. 320
BILANCIA	P. 324	MADERA	P. 304	TU-O_TU-V	P. 024
BOLL	P. 426	MAMI	P. 354	VULCANO	P. 246
BOX	P. 054	MARGE	P. 520	WALLY	P. 346
BOX_FULL LIGHT	P. 050	MARINA	P. 340	ZEBRA	P. 278
CABLE MONO SYSTEM	P. 442	MATRIOSKA	P. 350	ZIG ZAG	P. 250
CABLE 150 SYSTEM	P. 452	MET WALLY	P. 346		
CABLE 300 SYSTEM	P. 464	METAL	P. 292		
CAMPANA	P. 220	MILLE	P. 092		
CIRCULAR	P. 412	MOLEDRO	P. 298		
CONUS	P. 114	MOVE	P. 030		
CREW	P. 258	MYWHITE	P. 476		
CRUMB	P. 216	NOVE99	P. 312		
CUBIC	P. 439	OH! SMASH_IN	P. 388		
CURVÈ	P. 104	OH! SMASH_OUT	P. 506		
DELTA	P. 328	OH! SOLAR	P. 512		
DICE	P. 439	OH! UW	P. 516		
DUBLIGHT	P. 082	OH!_IN	P. 370		
ECOMOLLA	P. 324	OH!_OUT	P. 490		
ELIPSE	P. 439	OHPS_IN	P. 382		
FACE	P. 254	OHPS_OUT	P. 502		
FLOWER	P. 528	ONDA	P. 340		
FOTIS	P. 432	ONE TO ONE	P. 136		
GLUÈD	P. 072	ORBIS	P. 210		
GOCCIA	P. 426	OUTLOOK	P. 192		
GYPSUM_CELL	P. 150	PEGGY	P. 524		
GYPSUM_D	P. 168	PELOTA	P. 196		
GYPSUM_EYE	P. 154	PLAF	P. 486		
GYPSUM_ILL	P. 154	POE	P. 282		
GYPSUM_O	P. 154	PRIME	P. 416		
GYPSUM_Q	P. 168	ROSE	P. 068		
GYPSUM_R	P. 154	SIPARIO	P. 312		
GYPSUM_S	P. 168	SISTERS	P. 242		
GYPSUM_W	P. 182	SKINNY	P. 406		
GYPSUM_WF	P. 182	SNAKE	P. 124		
GYPSUM_WR	P. 182	SOLID	P. 420		
HALFPIPE	P. 396	SOLIDO	P. 308		
HELI	P. 110	SPARK	P. 270		
HORIZON	P. 046	SPOTTY	P. 203		
HULA HOOP	P. 316	SQUASH	P. 034		
ICEBERG	P. 340	STARDUST	P. 042		
INCASSO	P. 144	STRAIGHT_P	P. 018		

HOW TO... /

Family

Product information

Composition table:
code - colour - optics



MEETRE FOUNGHT LUMINARIO

/ 244

Mezzogiorno L&L Italia

Sistema | Fiume arrotto, di alluminio, in vetro soffiato. Sospensione in parallelo delle teste. Finiture del rame. Sospensione personalizzabile per spazi ristretti ed eleganti.

Materiali: allumini in polvere nera opaca, rame in ABS finiture opaco, oro opaco come.

Sistema_1 | Fountant Luminario (230-240 V) | 14527

Nome	Prezzo	Stato
Nome	€367	Tutti i Max
Nome	€305	oFunct
Nome	€305	

Sistema_2 | Fountant Luminario (230-240 V) | 14527

Nome	Prezzo	Stato
Nome	€304	Tutti i Max
Nome	€305	oFunct
Nome	€305	

/ 245

Product detail

Dimensioned technical drawing

FINISHES /



Iron Grey



Brushed Grey

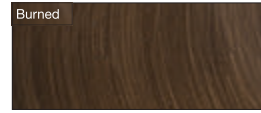

Burned



Concrete

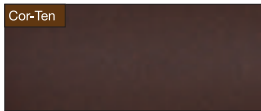

Cor-Ten

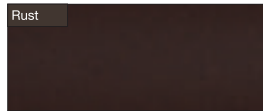

Rust

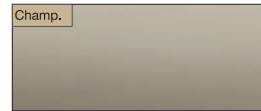

Champagne

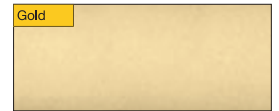

Gold



Copper



Chrome



Dark Chrome



Nickel



Transparent

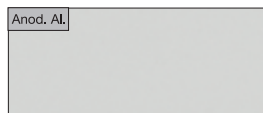

Anodized aluminum



Polished aluminum



Ash Wood



Oak Wood



Grey Oak Wood



Cherry Wood



Walnut Wood



Mesh Fabric

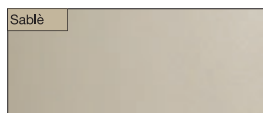

Sablè



Grey



Green



Brown



Black



White



Blue Glass



Red Glass



Orange Glass



Yellow Glass

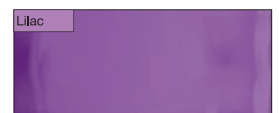

Lilac Glass



Amber Glass

SYMBOLS /

	Indoor installation		Quadrangular installation hole
	Outdoor installation		Single emission luminaire
	Wall mounting		Double emission luminaire
	Ground mounting		Device suitable to be mounted on furniture
	Ceiling mounting		Device suitable to be mounted on normally flammable surfaces (EN 60598)
	Wall or ground mounting		Device with integrated thermal protection
	Ceiling or wall mounting		Simply Dim
	Recessed mounting		Push Dim
	Ceiling or ground mounting		1-10 V
	Stainless steel		DMX 512
	Protection class (IEC 60529) against foreign bodies and water		DALI
	Protection index on the optical compartment		Constant Current
	Protection degrees (IEC 62262) against external mechanical impacts		Constant Voltage
	Directional light beam		Dimming
	Tilting light beam		Phase-cut
	Walk-over lighting fixture		Motion sensor
	Drive-over lighting fixture (2,500 kg)		
	Power supply cable included		
	Class I - IEC protection class		
	Class II - IEC protection class		
	Class III - IEC protection class		
	Driver included		
	Driver not included		
	Over Voltage Protection		
	Article protected by resin potting		
	Available in emergency version		
	Round installation hole		

All articles belong to energy class A++.

The lumens indicated refer to the light source emission.

The connection diagrams for electronics articles are included in the technical documentation.

The drawings, dimensions, materials and colours contained in this catalogue are merely indicative.

In the customers' interest, the Company reserves the right to modify the models at any time without notice.

ADDRESSED /

Linea Light S.r.l. Italy

via della Fornace, 59 z.i.
31023 Castelmio di Resana (TV) - Italy
Phone: +39 0423 78 68
Fax: +39 0423 78 69 00
info@linealight.com

LightVillage Milano - Exhibition Area Only

via Morimondo, 26 int. 17G
20143 Milano
Phone: +39 02 36750915
Fax: +39 02 36750915
milano@lightvillage.it

Linea Light France

Z.A. Heiden Est, 12 rue des Pays-Bas
68310 Wittelsheim - France
Phone: +33 389 75 52 23
Fax: +33 389 75 59 07
info@linealight.fr

Linea Light UK Ltd

Suite 109 - Business Design Centre
52 Upper Street - Islington N10QH - London - UK
Phone: +44 0203 6371983
info@linealight-uk.com

Linea Light Deutschland GmbH

Aktienstraße 214
45473 Mülheim a.d. Ruhr - Germany
Phone: +49 208 299979-0
Fax: +49 208 299979-10
service@linealight.de

Linea Light GCC - Middle East & Gulf Countries

Jumeirah Lake Towers
JBC2 - 35th Floor Office 02 - Dubai - UAE
P.O. Box 125902
Phone: +971 4 4218275
Fax: +971 4 4218274
info@linealight.ae

Linea Light Polska Sp. z o.o.

ul. Wiosenna, 47
41253 Czeladz - Poland
Phone: +48 32 265 11 21
Fax: +48 32 265 04 42
biuro@linealight.com.pl

Linea Light Russia

Luzhnetskaya nab., 2/4, str. 3, of. 304
119270 Moscow - Russian Federation
Phone: +7 495 639 99 41
info@linealight.ru

Linea Light USA | Inter Lux

3741 Commerce Drive
Suites 306-308
Baltimore, MD 21227 - USA
Phone: +1 410 381 1497
Fax: +1 410 381 1589
answers@inter-lux.com

Linea Light Asia-Pacific Ltd

YuXiang Industrial Area
528478 HengLan Town, ZhongShan City,
GuangDong Province, China
Phone: +86 760 87618355
Fax: +86 760 87553990
info@linealight.cn



linealight.com

Art direction:
Linea Light Group - Marketing Dept.

Concept:
SRCommunication Solutions

Photographers:
Studio Pointer
Studio Indoor
Luigi De Nadai

Copywriter:
Andrea Pietro Calatroni

Pre-press:
Studio Pointer
Z13

Press:
Graficart Arti Grafiche srl

Thanks to:
Valentini Interiors Snc (Padua, IT) and Valentini Srl – p.46, 48, 72, 216, 242, 244, 259, 270, 274, 275, 283
Torre di Porta Nuova and Arsenale di Venezia – p.77, 218, 272
Paolo Utimpergher and Studio Gobbo – p.279
Paolo Utimpergher and Toni Paolin – p.80
Paolo Utimpergher and Davide Varotto – p.106, 107
Paolo Utimpergher – p.260
Orme_Homes Casa Srl – p.36, 86
Fabio Gambina_Amelie toy library (Rome, IT) – p.154
Fabio Gambina and Gildo Meucci / 3D Light & Design Srl – p.466
Arch. Rosa Amato – p.156
Yannis Kontos Photojournalists and IFI Group_Doulgerakis Residence (Greece) – p.156
Yannis Kontos Photojournalists and IFI Group_Sirene Beach Hotel (Rhodes, GR) – p.158
IFI Group_Glyfada Residence (Greece) – p.168
Studio Tondo_Caffè degli Artisti (Nuoro, IT) – p.157
Ali Moshiri and Arch. Hascher & Jehle / Eng. Buro Krawinkel Krefeld_Neues Gymnasium (Bochum, DE) – p.184
Notorious Communication LAB_Linea Light Group 2015 and 2016 exhibition stands – p.150, 185
Alessandro Paderni / Eye Studio_Linea Light Group headquarter – p.2,6,7
Arch. Didonè & Comacchio_Linea Light Group Light Village @headquarter – p.4,5,37

Printed in Italy
July 2017



Your Light | Future Proof